

BUILDING ENVELOPE

Airtightness, wind resistance and fire protection for façades, doors and windows



rothoblaas

Solutions for Building Technology

BUILDING ENVELOPE

WHAT IS A BUILDING ENVELOPE?

The building envelope is the set of construction elements that separate the indoor environment from the outdoors, helping to protect the building and regulate indoor comfort.

Its main functions include protection from the weather, thermal insulation and soundproofing, airflow and humidity control, and the containment of energy consumption.

MAIN COMPONENTS OF THE ENVELOPE

Roofs

These can be pitched or flat, treadable or non-treadable.

Vertical façades

These include perimeter walls, ventilated façade systems, prefabricated elements and curtain walls.

Closing elements

Windows, French windows, glass panes, panels and insulation systems.

Horizontal closures

Floor slabs in contact with the ground, foundations or basements.

Their design directly impacts energy consumption, indoor comfort and the balance between technical performance, sustainability and long-term durability.

AIR AND WIND TIGHTNESS

The airtight envelope guarantees that in the winter, warm air and humidity inside the building are not lost to the outside, preventing interstitial condensation. The hermetic nature of the casing offers energy savings and comfortable living.



AIRTIGHTNESS [BARRIER, VAPOR, CLIMA CONTROL]

- ✓ Prevents heat loss in winter
- ✓ Prevents the entry of hot, humid air in summer
- ✓ Optimises the operation of controlled mechanical ventilation
- ✓ Prevents the uncontrolled passage of warm, moist air and the consequent risk of interstitial condensation
- ✓ Avoids discomfort due to draughts
- ✓ Improves acoustic comfort



WIND TIGHTNESS [TRASPIR]

- ✓ Ensures the thermal efficiency of the insulation layer
- ✓ Protects the casing and improves the durability of materials
- ✓ Avoids the formation of currents and convective motions within the casing
- ✓ Serves as a temporary protective layer during construction phases
- ✓ Acts as a temporary protective layer in the event of cracks and dislocation of the roof layer or façade cladding



CLOSING ELEMENTS



HORIZONTAL CLOSURES



ROOFS

VERTICAL
FAÇADES



AIR AND WIND TIGHTNESS

MONOLITHIC AND MICROPOROUS MEMBRANES

The family of synthetic breathable membranes and vapour control layers and barriers (that is, membranes made of materials deriving from polymers) offer different properties as a function of the production technologies and raw materials used in processing. Breathable membranes can be categorised into two main types: MICROPOROUS and MONOLITHIC.

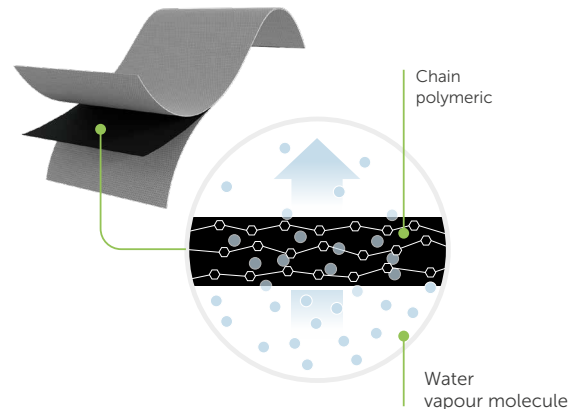
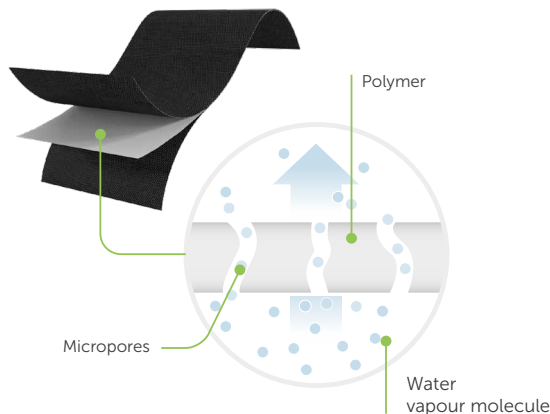

MICROPOROUS MEMBRANES

Membrane with functional microporous layer.

Resistance to temperature	●○○
Durability and stability with ageing	●●○
UV stability	●●○
Chemical stability	●○○
Fire behaviour	●○○
Breathability (water vapour)	●●●
Watertightness	●●○
Airtightness	●●○
Resistance to heavy rain	●●○
Mechanical resistance	●●●
Slipping resistance	●●●
Resistance to pollutants	○○○

MONOLITHIC MEMBRANES

Membrane with a homogeneous and continuous functional layer.

Resistance to temperature	●●●
Durability and stability with ageing	●●●
UV stability	●●●
Chemical stability	●●●
Fire behaviour	●●○
Breathability (water vapour)	●●●
Watertightness	●●●
Airtightness	●●●
Resistance to heavy rain	●●●
Mechanical resistance	●●●
Resistance to pollutants	●●●

EXCELLENT WEATHER RESISTANCE

MEMBRANE PERFORMANCE

The membranes undergo various tests to determine their performance. Based on these, it is possible to choose the most suitable solution for your project.

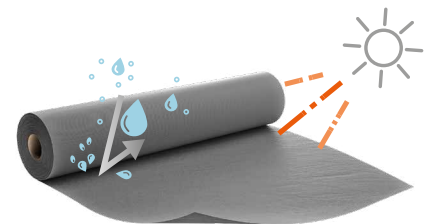

WATERTIGHTNESS

Ability of the product to temporarily prevent the passage of water during construction and in case of accidental breakage and dislocation of the roof covering.

This property indicates resistance to penetration of water.

Standard **EN 13859-1/2** establishes the following classification:

- **W1:** High resistance to penetration of water
- **W2:** Medium resistance to penetration of water
- **W3:** Low resistance to penetration of water

UV STABILITY AND AGEING

Resistance to water penetration, tensile strength and elongation must be determined after artificial ageing. The test method consists of exposing the specimens to continuous UV irradiation at elevated temperature for 336 hours. This corresponds to a total UV radiation exposure of 55 MJ/m².

It is conventionally regarded as equivalent to 3 months of average annual radiation in the Central European region.

For walls that do not exclude UV exposure with open joints, artificial ageing by UV must be extended over a period of 5000 hours.

NOTE: the data obtained from artificial ageing tests are comparative and not absolute, as there is no direct conversion factor with natural ageing

VENTILATED FACADES

HUMIDITY BEHAVIOUR

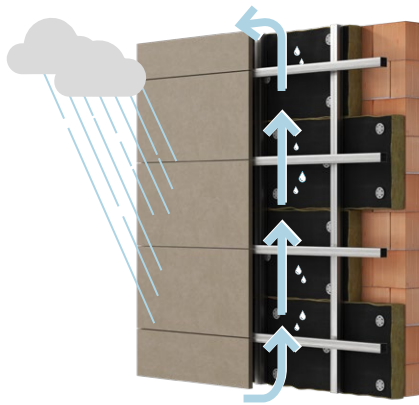

THERMAL INSULATION BEHAVIOUR

In a ventilated façade, the thermal insulation is protected by an air cavity and external cladding. If the system is not completely waterproof, rainwater infiltration may occur, which:

- Increases the thermal conductivity (lambda) of the insulation, compromising its insulating capacity
- Facilitates the formation of mould and deterioration of the material
- Compromises the durability of the entire system

For example, under 100% humidity conditions, the conductivity of mineral wool can almost double (from 0.0344 to 0.0626 W/m·K), and EPS also shows a significant increase (from 0.0334 to 0.0499 W/m·K).

Comparative thermal conductivity of insulating materials

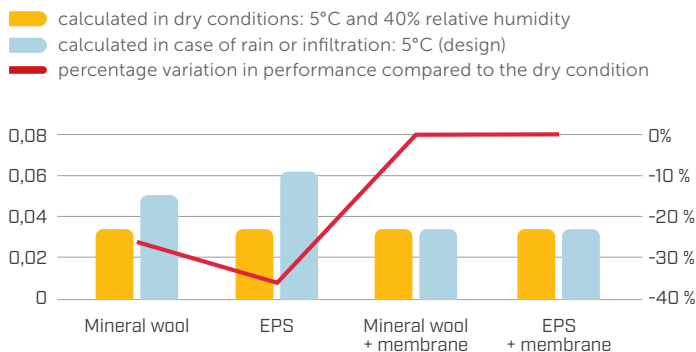

Breathable membranes with W1 classification according to standard EN 13859-1/2 are an effective solution:

- **Resistance to water penetration (W1):** they prevent rainwater from penetrating the insulation
- **Breathability:** they allow water vapour generated inside the building to escape, preventing condensation
- **Thermal stability:** by keeping the insulation dry, its original thermal performance is preserved

Insulation layer	λ calculated in dry conditions: 5°C and 40% relative humidity	λ calculated in case of rain or infiltration: 5°C		Percentage variation in performance compared to the dry condition
		material relative humidity	λ (project)	
(1) Mineral wool	0.0334	100%	0.0499	-33%
EPS	0.0334	100%	0.0606	-45%
(2) Mineral wool + membranes	0.0334	40%	0.0334	0%
(3) EPS + membranes	0.0334	40%	0.0334	0%

The table shows that the conductivity of thermal insulators increases in the presence of water. Membranes protect the insulating layer from rain and infiltration, preventing the deterioration of thermal performance.

EXAMPLES

1

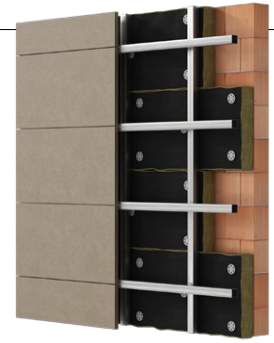

Ventilated façade with mineral wool insulation and black veil

The insulation is exposed to possible water infiltration and airtightness is not guaranteed. The black veil offers greater tensile strength, but its waterproofing capacity is unknown.

2



Ventilated façade with mineral wool insulation and aluminium-coated breathable membrane

Mineral wool insulation protected by an aluminium-coated breathable membrane with reaction-to-fire classification A2-s1, d0, and resistance to water penetration W1 according to EN 13859-1/2.

3

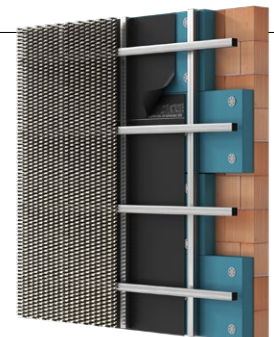

Ventilated façade with open joint and EPS insulation protected by UV-resistant membrane

Self-adhesive membrane with reaction-to-fire classification B-s1-d0, resistant to water and extreme temperatures. Essential in contexts highly exposed to weather conditions.

VENTILATED FAÇADES FIRE BEHAVIOUR

All building typologies have to consider fire safety issues, depending on the regulations in force and the intended use. This was done in order to minimise the causes of fire, ensure the stability of the structure and limit the spread of flames both inwards and towards neighbouring buildings, guaranteeing the safety of the occupants and access for rescue teams. In order to minimise this type of risk, it is essential to rely on the right components and to carefully design them. Our ventilated façade solutions minimise risks by limiting the spread of flames in the event of an internal or external fire.

FIRE SPREAD PHASES IN A VENTILATED FAÇADE

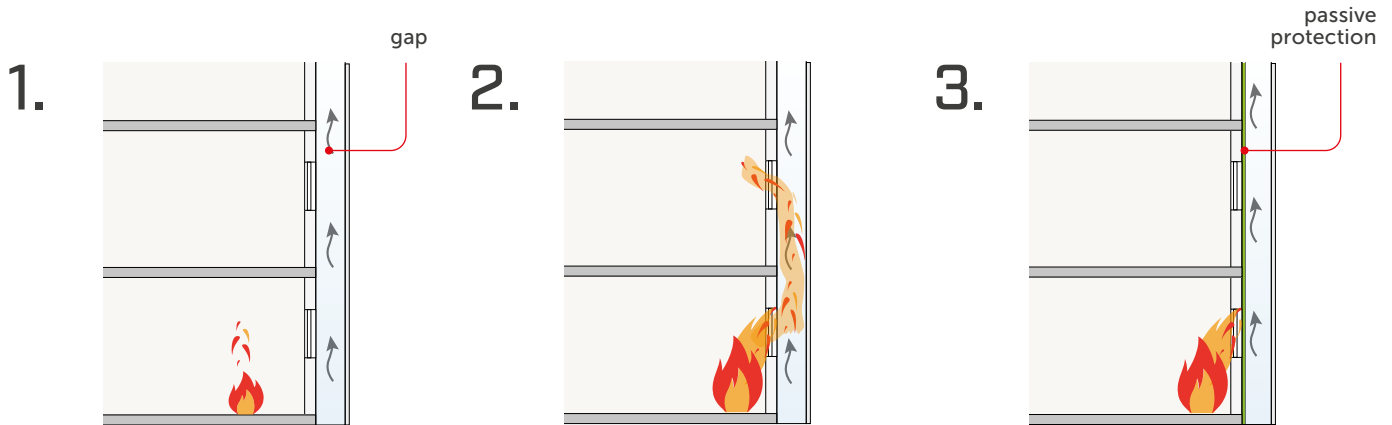

In the event of a fire starting inside the building, the flames initially spread to the room where they started. Modern buildings with ventilated façades are designed to take full advantage of the chimney effect of the ventilated façade, to reap the benefits of the upward movement of air in the gap between the cladding and the insulating layer. It is precisely this phenomenon that can give rise to problems in the event of a fire.

In the event of a fire, the **CHIMNEY EFFECT** of the ventilated façade could cause problems as it could direct the flames into the ventilation space, pushing them towards the upper floors of the building.

CHIMNEY EFFECT

The chimney effect is a physical phenomenon – the same principle that governs the operation of traditional chimneys. In architecture, it is applied to ventilated façades: the upward movement of the warm air generated inside the ventilated cavity creates a continuous exchange, improving ventilation and contributing to the indoor comfort of the building.

Careful fire protection design includes active or passive protection devices within the design with the purpose to prevent the spread of any flames. Rothoblaas proposes the use of self-extinguishing membranes and tapes as a passive façade solution. If no preventive measures are taken, the combustion of materials could lead to flames on the upper floors. The same concepts also apply in the case of a fire developed outside the building.

REACTION TO FIRE

European classification according to EN 13501-1

The fire reaction rating is an indicator that assesses the propensity of a material to contribute or otherwise to fire growth. Different material behaviours correspond to different classes, ranging from non-combustible products to extremely flammable materials.

	Class A1	non-combustible products
⋮	Classes A2, B, C, D, E	combustible products, with an increasing contribution to fire from the lowest level (A2) to the highest (E)
	Class F	products with Non-Determined Performance (NDP) or that do not reach Class E
	s1, s2, s3	indicate the optical density of smoke (from low to high)
	d0, d1, d2	indicate the danger level of droplets or flaming particles (from absent to high)



Discover the different flame reactions of our products! Watch the video on our YouTube channel

SUBSCRIBE



AIRTIGHTNESS VAPOUR BARRIER



BARRIER ALU FIRE A2 SD2500

REFLECTIVE VAPOUR BARRIER
REACTION TO FIRE IN CLASS A2-s1,d0

The reflectivity of the membrane improves the energy performance of the construction panels: reflecting heat inwards up to 95% it increases thermal resistance.



BARRIER ALU NET ADHESIVE 300

SELF-ADHESIVE REFLECTIVE
VAPOUR BARRIER Sd > 1500 m

Maximum resistance to steam and radon gas penetration thanks to its unique composition.



BARRIER ALU NET SD1500

REFLECTIVE VAPOUR BARRIER
Sd > 1500 m

Aluminium-coated vapour barrier screen characterised by a very high Sd value.

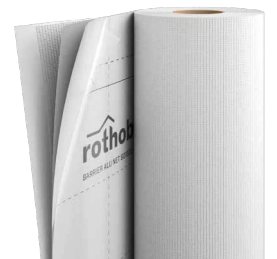

RADON FLOOR

WATERPROOF RADON GAS BARRIER FOR
FOUNDATIONS

Certified barrier against radon and humidity, consisting of two layers of reinforced polyethylene. High durability is ensured by the double reinforcing layer and it can be applied on both inside and outside walls in contact with the ground.



Download the catalogue
**TAPES, MEMBRANES,
SEALANTS AND FIRE
PROTECTION**

The only element
that protects you
from the others



rothoblaas

Solutions for Building Technology

WIND TIGHTNESS

HIGHLY BREATHABLE MEMBRANES



TRASPIR ALU FIRE A2 430

REFLECTIVE HIGHLY BREATHABLE MEMBRANE

Membrane tested in accordance with EN 13501-1 and A2 classified. It can also be applied in combination with photovoltaic panels and in all contexts where a specific level of fire protection is required.

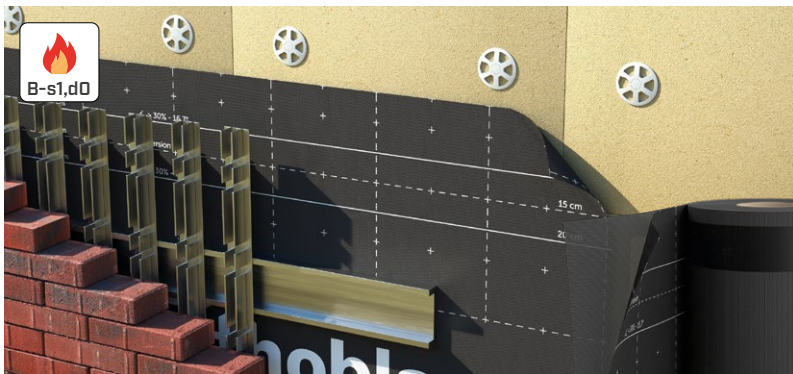

TRASPIR EVO 300

HIGHLY BREATHABLE MONOLITHIC MEMBRANE

High-durability monolithic breathable membrane ensuring high waterproofing and excellent reaction to fire. Designed for application on the outer and inner sides of roofs and façades.

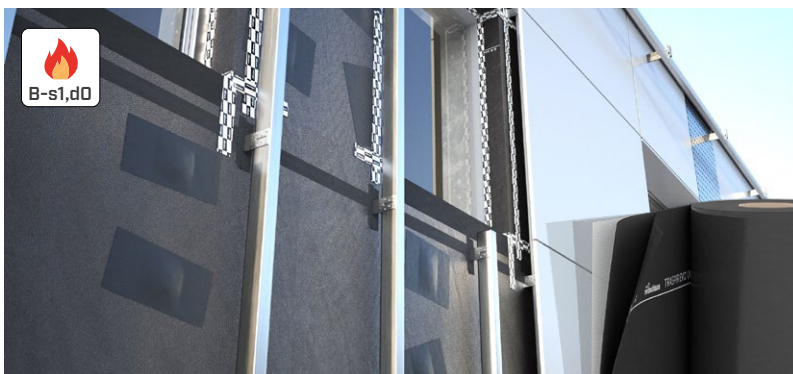

TRASPIR EVO UV ADHESIVE

SELF-ADHESIVE BREATHABLE MONOLITHIC MEMBRANE RESISTANT TO UV RAYS

Made of a special polymer blend and featuring an adhesive film, the monolithic structure ensures high resistance to atmospheric and chemical agents, guaranteeing 10 weeks of temporary protection. It has fire reaction B-s1,d0 and flame retardant capacity according to EN 13501-1.



TRASPIR EVO UV 210

HIGHLY BREATHABLE MONOLITHIC MEMBRANE RESISTANT TO UV RAYS

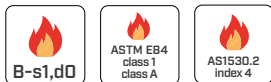

TRASPIR EVO UV 115

BREATHABLE MONOLITHIC MEMBRANE RESISTANT TO UV RAYS

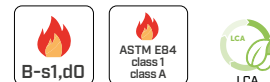

DEFENCE ADHESIVE TRASPIR EVO

SELF-ADHESIVE BREATHABLE MONOLITHIC MEMBRANE



TRASPIR EVO 160

MONOLITHIC BREATHABLE MEMBRANE

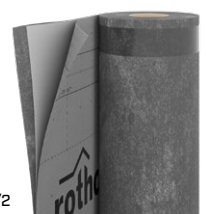

WIND TIGHTNESS MEMBRANE SEALING



TERRA BAND UV BUTYL ADHESIVE TAPE

Ideal for protecting battens from water and UV rays. Can be used for both patios and façades, protecting and extending the life of the wooden joists.

The reinforced aluminium layer and butyl compound make it ideal for continuous façades where small areas of water stagnation due to condensation need to be managed.

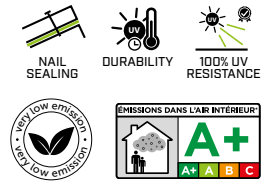

FACADE BAND UV

UNIVERSAL SINGLE-SIDED TAPE,
RESISTANT TO UV RAYS



FRONT BAND UV 210

UNIVERSAL SINGLE-SIDED TAPE,
HIGHLY RESISTANT TO UV RAYS



FLEXI BAND UV

UNIVERSAL SINGLE-SIDED ADHESIVE
TAPE WITH HIGH UV STABILITY AND
TEMPERATURE RESISTANCE

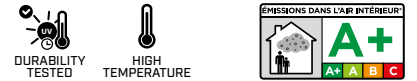

FLUID MEMBRANE

SYNTHETIC SEALING MEMBRANE FOR
BRUSH AND SPRAY APPLICATION



PROTECT

SELF-ADHESIVE BUTYL BAND, CAN BE
PLASTERED

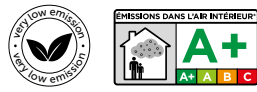

GROUND BAND

SELF-ADHESIVE BITUMINOUS
MEMBRANE

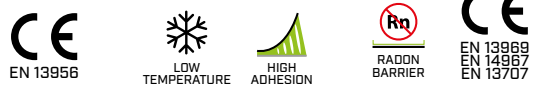

RELATED PRODUCTS

PUMP SPRAY

ELECTRIC
AIRLESS
SPRAYER



ROLLER

ROLLER FOR TAPES



PRIMER SPRAY

UNIVERSAL SPRAY PRIMER
FOR ACRYLIC ADHESIVE
TAPES



FAÇADES FASTENING



WKF ANGLE BRACKET FOR FAÇADES

It is ideal for cladding on new and existing structures. Installation on timber, masonry and concrete walls. Reinforcements are designed to ensure high levels of stiffness. Fast and easy installation.

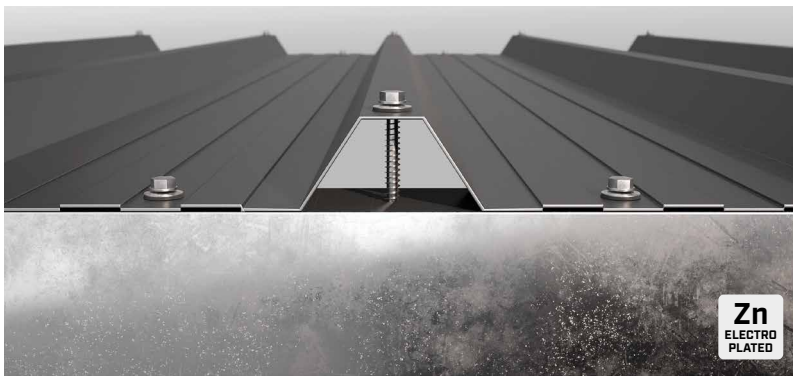

SAR SELF-DRILLING SCREW FOR STEEL, HEXAGONAL HEAD

Complete with integrated washer with EPDM seal for watertight fastening.

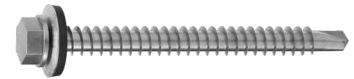

Zn
ELECTRO
PLATED



FAS A4 | AISI316 SCREWS FOR FAÇADES

Thanks to its flange head, partially threaded body and self-drilling tip, it is the appropriate screw for fastening façade panels on timber battens.



A4
AISI 316



ISULFIX ANCHOR FOR FASTENING INSULATION TO BRICKWORK

Ø8 PVC double expansion anchor with pre-assembled steel nails, for fastening to concrete and brickwork. Can be used, with an additional washer, on particularly soft insulating materials.



✓ RELATED PRODUCTS

■ **THERMOWASHER**
WASHER TO FASTEN
INSULATION
TO TIMBER



■ **A 18 | ASB 18**
CORDLESS
SCREWDRIVER



■ **HEADPHONE**
FOLDING EAR MUFFS



FAÇADES FASTENING



SKR | SKS | SKP

SCREW-IN ANCHOR FOR CONCRETE

The special threading requires a small pre-drill and guarantees fastening on concrete without creating expansion stresses within it.

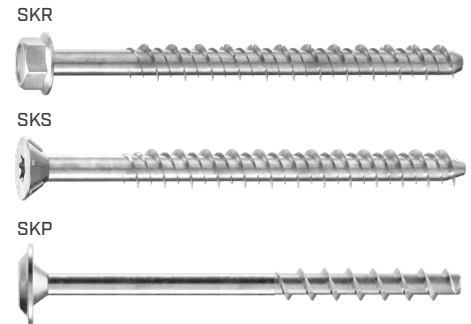

SKR EVO | SKS EVO

SCREW-IN ANCHOR FOR CONCRETE

Screw-in anchor in outdoor version with C4 EVO coating, suitable for atmospheric corrosivity class C4 and service class 3.



AB1

HEAVY DUTY EXPANSION ANCHOR CE1

AB1 is a through-bolt expansion anchor with torque-controlled installation, delivering maximum static and seismic mechanical performance. Fire resistance R120.



ABE

HEAVY DUTY EXPANSION ANCHOR CE1

Certified to CE option 1 for cracked and uncracked concrete and for seismic action classes C1 and C2.



ABE A4

HEAVY DUTY EXPANSION ANCHOR CE1

Excellent mechanical performance – both static and seismic – combined with the very high corrosion resistance of stainless steel A4 | AISI316.



RELATED PRODUCTS

P 26 C
COMBI
HAMMER



SNAIL PULSE
DRILL BIT IN HM



PONY
POCKET AIR PUMP FOR
HOLE CLEANSING



FAÇADES FASTENING



VIN-FIX

VINYL ESTER CHEMICAL ANCHOR WITHOUT STYRENE

Certified for masonry use in solid and semi-hollow material (categories b, c, d) and aerated autoclaved concrete blocks (AAC). Effective on both dry and wet concrete, as well as concrete with submerged holes.



ETA-20/0363
ETA-21/0982

HYB-FIX

HIGH-PERFORMANCE HYBRID CHEMICAL ANCHOR

It is the high-performance hybrid chemical anchor ideal for extra-heavy anchor systems and for recasting with reinforcing bars. Effective even on wet concrete and on concrete with submerged holes.



ETA-20/1285

EPO-FIX

HIGH-PERFORMANCE EPOXY CHEMICAL ANCHOR

Designed to offer the most reliable solution for extra-heavy anchors and reinforcement rods, it is characterised by its excellent adhesion and strength, even under extreme conditions.



ETA-23/0419
ETA-23/0420

VIN-FIX PRO NORDIC

VINYL ESTER CHEMICAL ANCHOR FOR LOW TEMPERATURES

The reliability and speed of vinyl ester resin, with a composition designed to deliver maximum performance even at very low temperatures.

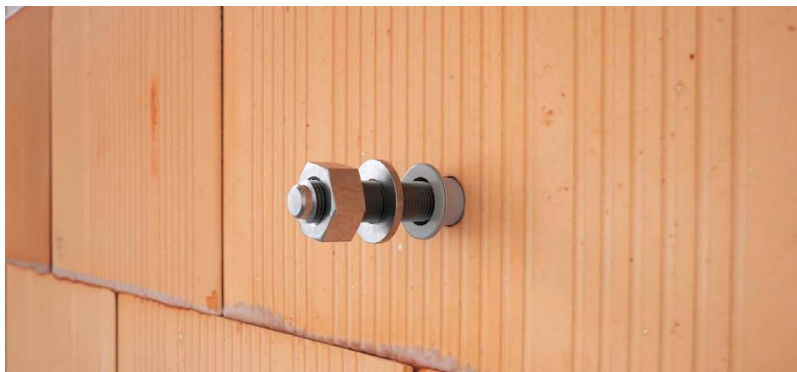

INA

5.8 AND 8.8 STEEL CLASS THREADED ROD FOR CHEMICAL ANCHORS

Optimised lengths to maximise rod strength in concrete applications and to avoid waste.

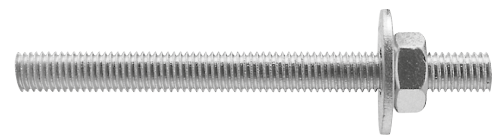

RELATED PRODUCTS

IHP

BUSHINGS FOR PERFORATED MATERIALS.
PLASTIC MESH

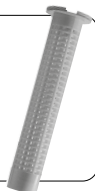

IHM

BUSHINGS FOR PERFORATED MATERIALS.
WIRE MESH



BRUH





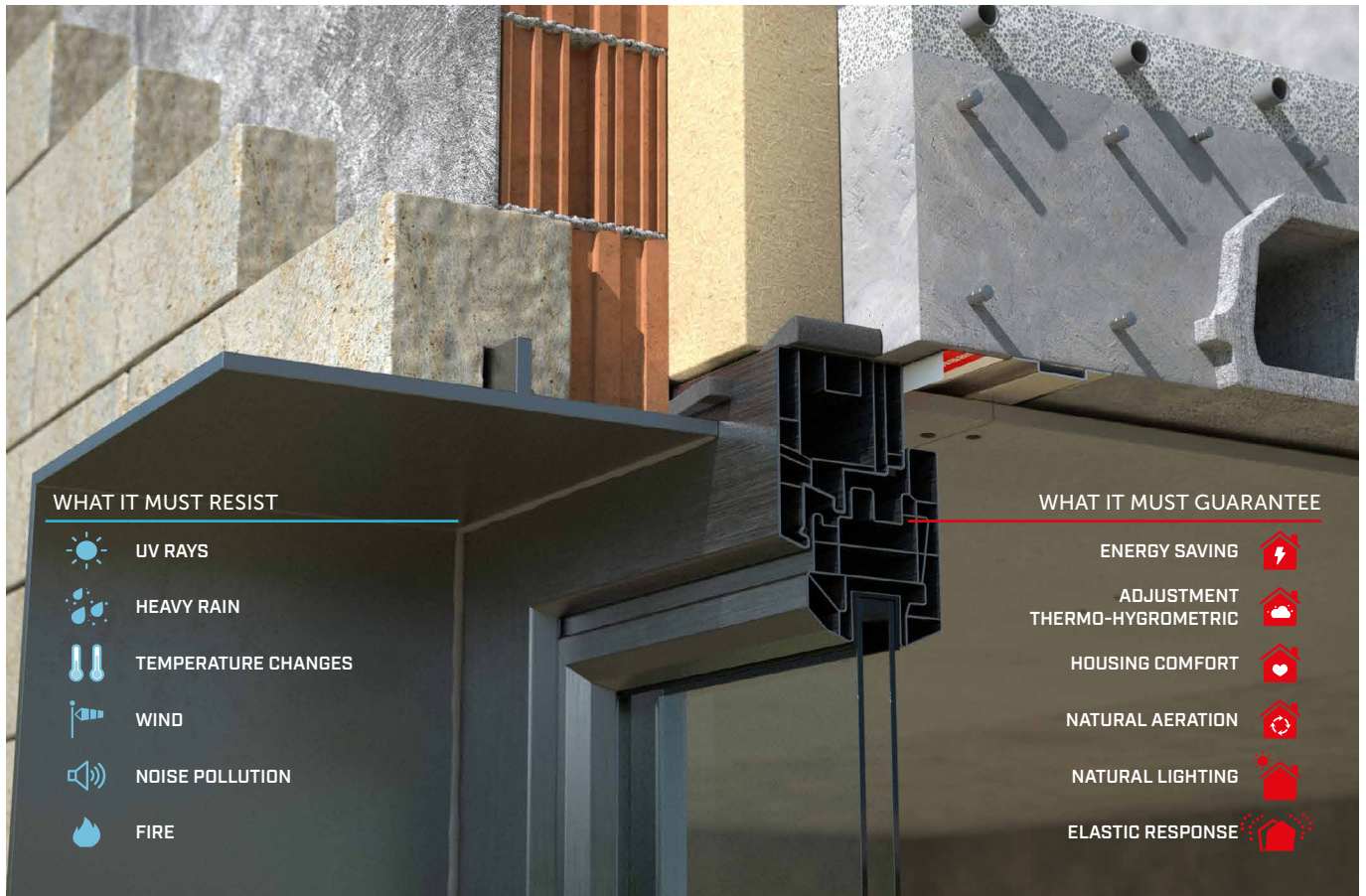

STEEL PIPE CLEANER



DOORS, WINDOWS AND STRUCTURE



WHAT IT MUST RESIST

-  UV RAYS
-  HEAVY RAIN
-  TEMPERATURE CHANGES
-  WIND
-  NOISE POLLUTION
-  FIRE

WHAT IT MUST GUARANTEE

- ENERGY SAVING 
- ADJUSTMENT THERMO-HYGROMETRIC 
- HOUSING COMFORT 
- NATURAL AERATION 
- NATURAL LIGHTING 
- ELASTIC RESPONSE 

THREE LEVELS OF PROTECTION

The three-level method, adopted at European level, defines the requirements for airtightness, wind resistance and thermal-acoustic insulation for the correct installation of doors and windows. To achieve optimal performance, it is important that each level be carefully considered at the design stage. Rothoblaas provides dedicated solutions for each level of protection.

WIND TIGHTNESS LEVEL

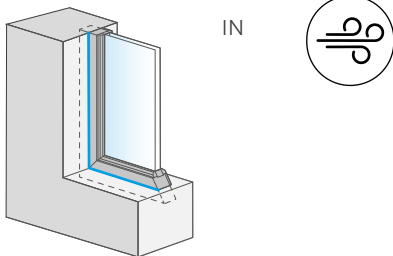

OUT

The most external level must guarantee protection against weather. If not properly developed, it can cause infiltration and water stagnation in the lower part of the window opening.

THERMAL AND ACOUSTIC INSULATION LEVEL

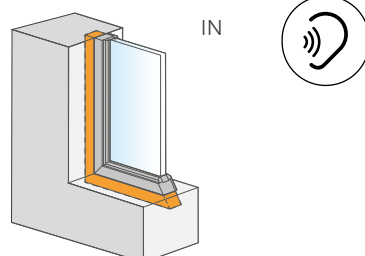

OUT

The intermediate level must guarantee thermal-acoustic performance and the mechanical fixing of the door/window frame. When selecting products, it is important to remember that an effective noise reduction solution does not always equate to good thermal insulation.

AIRTIGHTNESS LEVEL

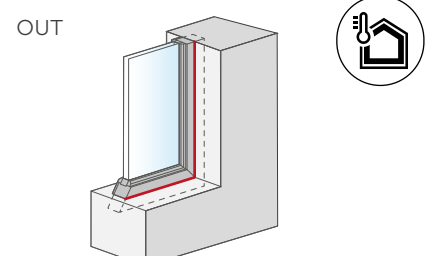

IN

The innermost layer must ensure airtightness, preventing the passage of air laden with water vapour that could cause condensation in the installation joints and mould on the surface.



PLASTER BAND IN/OUT

SPECIAL HIGH-ADHESION TAPE,
CAN BE PLASTERED

Its excellent adhesion makes it ideal for application on most surfaces, even at low temperatures.



MULTI BAND UV

SPECIAL UV-RESISTANT HIGH-ADHESION TAPE

The B-s1,d0 fire reaction and flame retardant capacity according to EN 13501-1 make it one of the best performing tapes on the market.



PLASTER BAND LITE

TAPE WITH ADHESIVE MOUNTING STRIP,
CAN BE PLASTERED

Tape that can be plastered which controls the flow of vapour. Thanks to the integrated adhesive mounting strip, application is quick and easy. Available in several variants to ensure tightness on every installation surface. It is also suitable for greater insulation or cladding thicknesses.



SMART BAND

UNIVERSAL SINGLE-SIDED TAPE WITH
SEPARABLE LINER

It meets all the requirements to be classified as a tape for sealing external doors or windows, ensuring maximum safety even in case of stagnant water, heavy rain and perforations.



✓ RELATED PRODUCTS

OUTSIDE GLUE

HIGH ELASTICITY UNIVERSAL
ADHESIVE GLUE FOR
EXTERNAL USE



PRIMER

UNIVERSAL PRIMER FOR
ACRYLIC ADHESIVE TAPES



PRIMER SPRAY

UNIVERSAL SPRAY PRIMER
FOR ACRYLIC ADHESIVE
TAPES



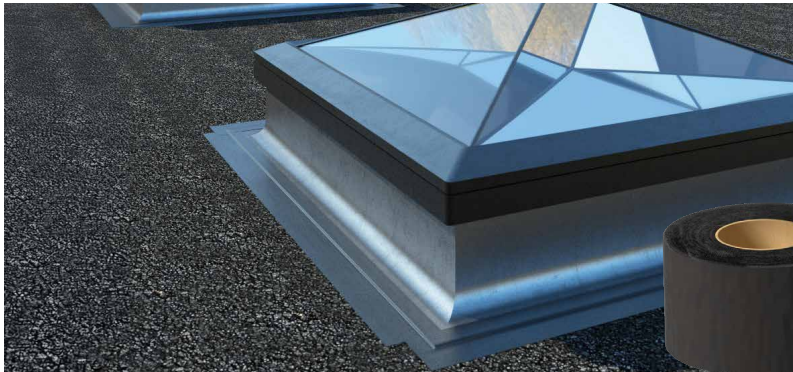
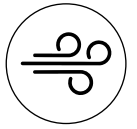

TERRA BAND UV
BUTYL ADHESIVE TAPE

Ideal for protecting battens from water and UV rays. Can be used for both patios and façades, protecting and extending the life of the wooden joists.



ALU BUTYL BAND
REFLECTING BUTYL ADHESIVE TAPE

The butyl composition offers excellent adhesion on the most common surfaces, even very porous ones. The reinforced aluminium coating protects the butyl mixture, guaranteeing that the seal lasts.

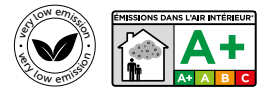

BYTUM BAND
SELF-ADHESIVE BITUMINOUS BAND,
CAN BE PLASTERED

The PP fabric means the product can be plastered, offering greater versatility of use. The bituminous mixture guarantees good adhesion, even on concrete.



INVISI BAND
TRANSPARENT SINGLE-SIDED ADHESIVE
TAPE WITHOUT LINER, RESISTANT TO UV
AND HIGH TEMPERATURES



FLEXI BAND UV
UNIVERSAL SINGLE-SIDED ADHESIVE
TAPE WITH HIGH UV STABILITY AND
TEMPERATURE RESISTANCE



FLEXI BAND
UNIVERSAL SINGLE-SIDED HIGH-
ADHESION TAPE



✓ RELATED PRODUCTS

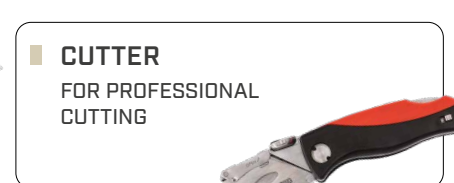
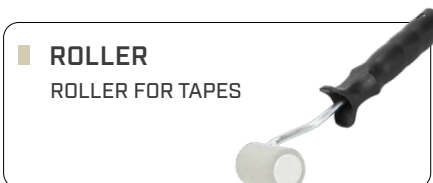



EXPAND BAND

SELF-EXPANDING SEALING TAPE

Thanks to its high elasticity, it can seal even irregular gaps, ensuring the airtightness of the joint.



WINDOW BAND

SELF-EXPANDING SEALING TAPE FOR WINDOWS/DOORS

It seals the joints of doors and windows from air and heavy rain while maintaining the thermal-acoustic properties over the entire depth.

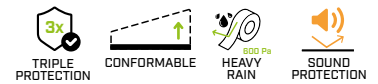

HERMETIC FOAM

HIGH PERFORMING SOUNDPROOFING SEALING FOAM

Waterproof and airtight, even if trimmed after hardening, thanks to the closed-cell structure.



SMART FOAM

GENERAL PURPOSE FOAM SEALANT

The special formula controls the foam's expansion post-application, preventing excessive pressure on the glued elements.



FIRE FOAM

HIGH FIRE-RESISTANT SEALING POLYURETHANE FOAM

Maximum protection against the passage of flames, smoke or gas. The only ETA tested and certified foam for fire protection and sealing of linear joints and cracks.



RELATED PRODUCTS

KOMPRI CLAMP

EXPANDING TAPE STAPLE



FLY FOAM

AUTOMATIC LONG TUBE GUN FOR FOAMS



FOAM CLEANER

DETERGENT FOR CARTRIDGE GUNS



DOORS, WINDOWS AND STRUCTURE AIRTIGHTNESS LEVEL



MS SEAL

MS POLYMER HIGH ELASTICITY SEALANT

MS SEAL, a pure, single-component sealing with practically no shrinkage and high elasticity, offers an alternative for airtightness in the case of visibly sealed joints, including those subject to movement.



FIRE SEALING SILICONE

HIGH FIRE-RESISTANT SILICONE SEALANT

Designed to guarantee maximum protection against the passage of flames, smoke and gas. The silicone polymer remains intact even when exposed to UV radiation, with no surface micro-cracks or chalking observed years after installation.

The product is also an acoustic sealant tested to restore the sound reduction index of walls where through-openings have been created.



✓ RELATED PRODUCTS

FLY SOFT
GUN FOR 600 ml
SOFT CARTRIDGES



FLY
PROFESSIONAL GUN FOR
310 ml CARTRIDGES



FROM THEORY TO INSTALLATION

On the Rothoblaas BLOG you'll find technical articles on waterproofing to guide you in your on-site choices.



DOORS, WINDOWS AND STRUCTURE FASTENING



Zn
ELECTRO
PLATED

MBS - MBZ

SELF-TAPPING SCREW FOR MASONRY

The countersunk head (MBS) allows PVC window frames to be installed without damaging the frame. The cylindrical head (MBZ) is able to penetrate and remain embedded in timber frames.

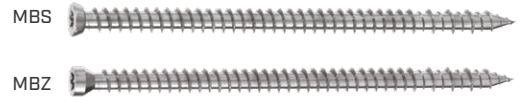

Zn
ELECTRO
PLATED

A2
AISI 304

SBN - SBN A2 | AISI304

SELF-DRILLING METAL SCREW

For fastening clips and metal profiles to steel or aluminium sheets of the building envelope. No pre-drilling, secure grip even on low thicknesses. A2 version for outdoor applications.



Zn
ELECTRO
PLATED

A2
AISI 304

SBS - SBS A2 | AISI304

SELF-DRILLING METAL SCREW

Structural screw for timber-to-metal connections. Self-drilling tip for aluminium and steel with no pre-drilling. The wings protect the thread and optimise adhesion. A2 version for outdoor applications.

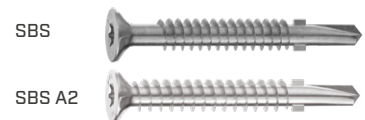

CE
EN 14592

HTS

FULLY THREADED COUNTERSUNK SCREW

A fine thread is ideal for utmost screwing precision.

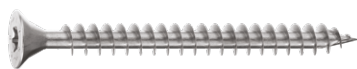

Zn
ELECTRO
PLATED

CE
EN 14592

HBS

COUNTERSUNK SCREW FOR WOOD

Certified for all structural applications, it has a high wood pull-through capacity and superior seismic performance.



Zn
ELECTRO
PLATED

CE
ETA-11/0030

RELATED PRODUCTS

■ **HH14505991**
BIT WITH METRIC
CONNECTION



■ **WBR**
STANDARD ANGLE
BRACKETS

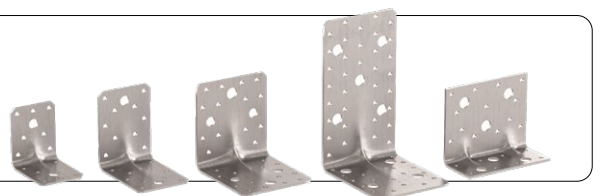

BUILDING ENVELOPE SAFETY MAINTENANCE

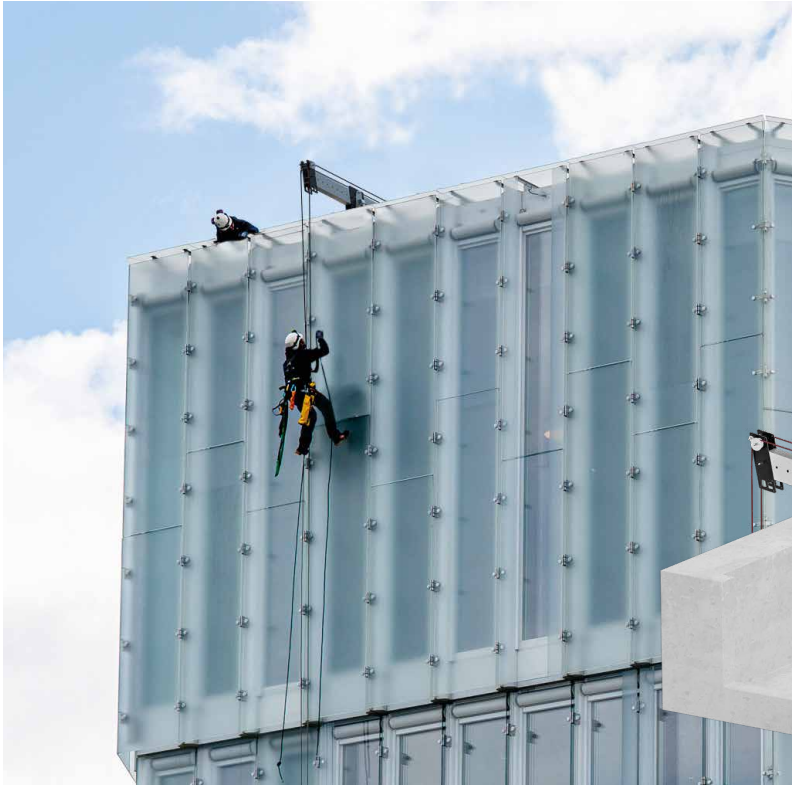

C-LEVER

DIVERSION SYSTEM FOR ROPE ACCESS AND FAÇADE WORK

The adjustable structure allows the configuration to be adapted, and railings or obstacles of varying sizes to be easily overcome. The smart integration of the ropes within the system simplifies use and recovery operations.

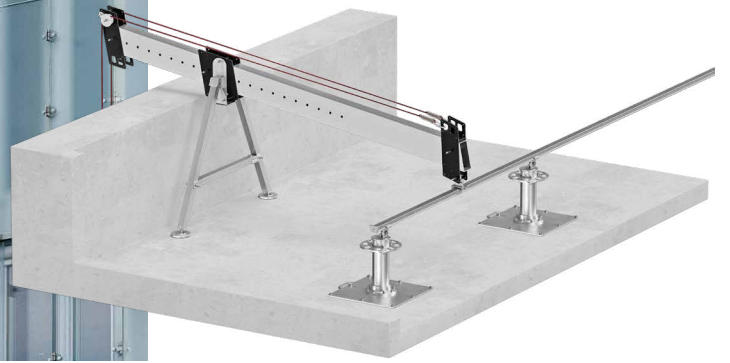

H-RAIL

RAIL SYSTEM FOR HORIZONTAL AND VERTICAL USE

The H-RAIL rail system is safe and versatile. It can be used to create rigid horizontal or vertical anchor lines with minimal fastenings. Either curved or straight rigid anchor lines can be developed thanks to the system's modularity. H-RAIL is also suitable for rope access work on building façades.



✓ RELATED PRODUCTS

SOLID

RIGID ANCHOR POINT FOR ROPE ACCESS WORK



HERO

HELMET FOR WORK AT HEIGHT, ON CONSTRUCTION SITES OR IN INDUSTRIAL AREAS



MAIA

PROFESSIONAL HARNESS



- FASTENING
- AIRTIGHTNESS AND WATERPROOFING
- SOUNDPROOFING
- FALL PROTECTION
- TOOLS AND MACHINES

rothoschool



TRAINING COURSES FOR OPERATORS AND DESIGNERS

Through partnerships with universities, research centres and specialized companies around the world, the training activities organized by Rothoblaas technicians involve experts with proven experience and expertise.

Whether you are a carpenter or a designer, having an interest in structural aspects of the envelope or in safety, you will find the course that is right for you.



Choose the course according to your needs
www.rothoblaas.com/rothoschool



Rotho Blaas Srl

Via dell'Adige N.2/1 | 39040, Cortaccia (BZ) | Italia
Tel: +39 0471 81 84 00 | Fax: +39 0471 81 84 84
info@rothoblaas.com | www.rothoblaas.com

