

GUIDA DISTANZE MINIME: PUNTE A CONFRONTO

TRANSIZIONE 2023-2026

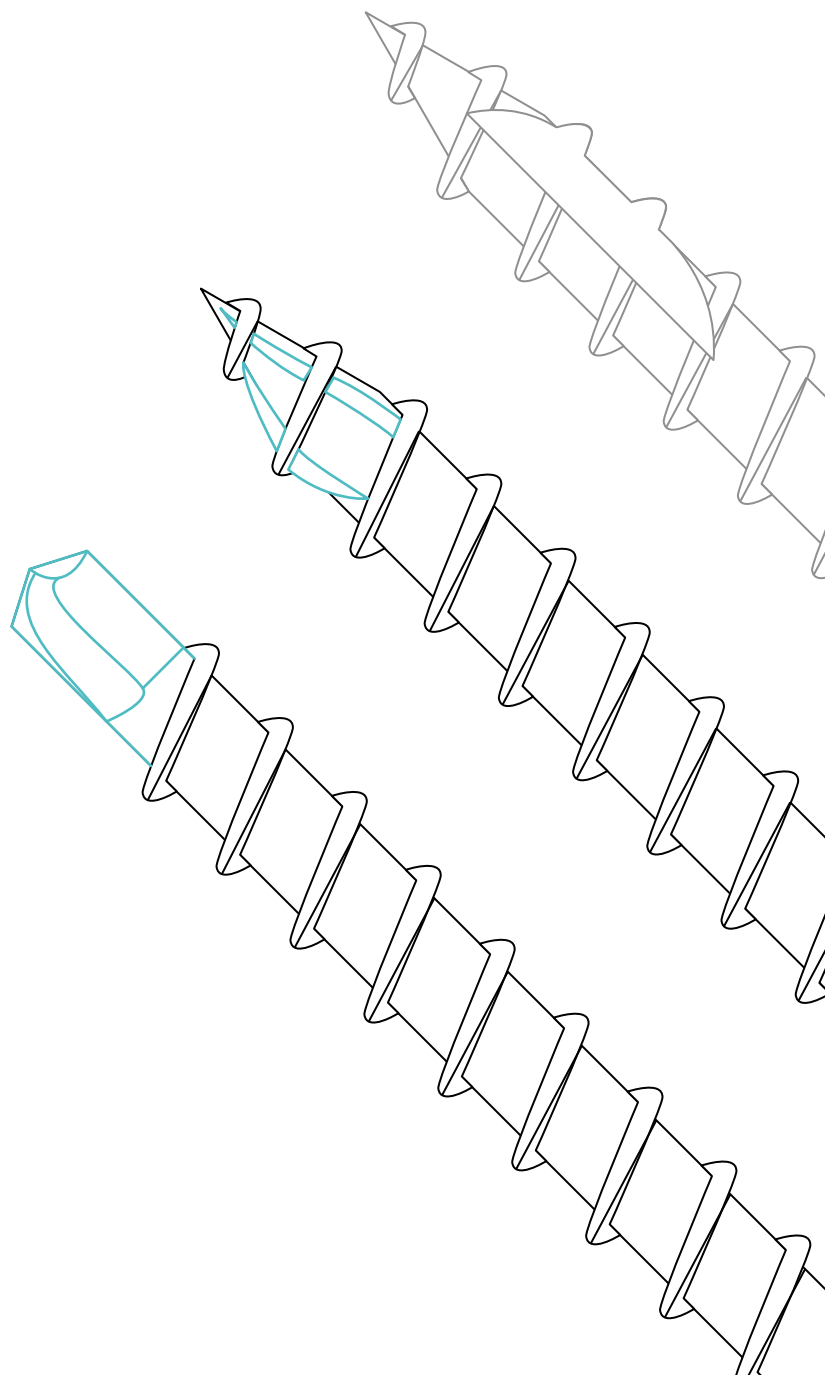

**rothoblaas**

Solutions for Building Technology

INDICE

VITI E TRANSIZIONE PUNTE	3
---------------------------------------	---

DISTANZE MINIME PER VITI SOLLECITATE A TAGLIO

PUNTE A CONFRONTO	4
VALORI CALCOLATI	6
VITI FILETTO PARZIALE	
<i>LEGNO</i>	6
<i>ACCIAIO-LEGNO</i>	8
VITI FILETTO TOTALE	
<i>LEGNO</i>	10

DISTANZE MINIME PER VITI SOLLECITATE ASSIALMENTE

PUNTE A CONFRONTO	12
VALORI CALCOLATI	13

DISTANZE MINIME PER CONNETTORI INCROCIATI

PUNTE A CONFRONTO	14
VALORI CALCOLATI	15

LEGENDA

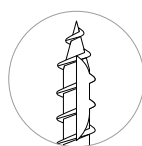

punta standard
SHARP 1 CUT
tipo *RBN / RBN2*

(in graduale transizione verso 3 THORNS e SELF-DRILLING)

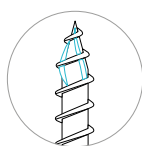

punta
3 THORNS
tipo *RB3T*

(disponibile a partire da **primavera 2024**)

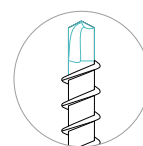

punta
SELF-DRILLING
tipo *RBSD*

(disponibile a partire da **primavera 2024**)

La sostituzione completa delle punte 3 THORNS e SELF-DRILLING avverrà entro il 2026.
Per informazioni riguardo alla disponibilità dei codici di viti con punte specifiche, contattare il Tecnico Commerciale di riferimento.

Nessuna garanzia della conformità legale e/o al progetto dei dati e dei calcoli è fornita da Rotho Blaas Srl, che mette a disposizione strumenti indicativi quale servizio tecnico-commerciale nell'ambito dell'attività di vendita. Rotho Blaas Srl segue una politica di continuo sviluppo dei propri prodotti, riservandosi pertanto il diritto di modificare le caratteristiche degli stessi, le specifiche tecniche ed altra documentazione senza preavviso. È dovere dell'utilizzatore o del progettista responsabile verificare ad ogni utilizzo la conformità dei dati alla normativa vigente e al progetto. La responsabilità ultima della scelta del prodotto adeguato per una specifica applicazione spetta all'utilizzatore/progettista.

I valori derivanti dalle "indagini sperimentali" sono basati sui risultati effettivi dei test e validi esclusivamente per le condizioni di prova indicate.

Rotho Blaas Srl non garantisce e in nessun caso potrà essere ritenuta responsabile in merito a danni, perdite e costi o altre conseguenze, a qualsiasi titolo (garanzia per vizi, garanzia per malfunzionamento, responsabilità del prodotto o di legge, ecc.) correlati all'utilizzo o all'impossibilità di utilizzare i prodotti per qualsiasi scopo; ad un uso non conforme del prodotto; Rotho Blaas Srl è sollevata da ogni responsabilità per eventuali errori di stampa e/o battitura. In caso di divergenze di contenuti tra versioni del catalogo nelle varie lingue, il testo italiano è vincolante e prevalente rispetto alle traduzioni. L'ultima versione delle schede tecniche disponibile è consultabile sul sito web Rotho Blaas.

Le illustrazioni sono parzialmente completate con accessori non inclusi. Le immagini sono a scopo illustrativo. L'uso di loghi e marchi di terze parti nel presente catalogo è previsto nei tempi e nei modi di cui nelle condizioni generali di acquisto, ove non diversamente concordato con il fornitore. Le quantità di imballo possono variare.

Il presente documento è proprietà privata di Rotho Blaas Srl e non può essere copiato, riprodotto o pubblicato, anche per stralci, senza preventivo consenso scritto. Ogni violazione è perseguita a norma di legge.

Le condizioni generali di acquisto e di vendita Rotho Blaas sono reperibili sul sito www.rothoblaas.it

VITI E TRANSIZIONE PUNTE







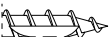

d x L

2023 >>>>>>> 2024/2026





FILETTO PARZIALE - TESTA SVASATA

	SHS	all		
	SHS AISI410	all		
	HBS	all		
	HBS EVO	all		

FILETTO PARZIALE - TESTA LARGA

	TBS	all		
	TBS MAX	all		
	TBS EVO	all		

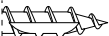











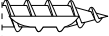







FILETTO PARZIALE - FISSAGGIO PIASTRE

	HBS PLATE	all		
	HBS PLATE EVO	all		
	KKF	all		

FILETTO TOTALE - TESTA CILINDRICA

	VGZ	Ø7		
		Ø9 L ≤ 520		
		Ø9 L > 520		
		Ø11 L ≤ 600		
	VGZ EVO	Ø11 L > 600	-	
		all		

FILETTO TOTALE - TESTA SVASATA

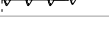
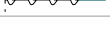
	VGS	Ø9 L ≤ 520		
		Ø9 L > 520		
		Ø11 L ≤ 600		
		Ø11 L > 600		
		Ø13 L ≤ 600		
		Ø13 L > 600		
	VGS EVO	Ø9		
		Ø11		
		Ø13 L ≤ 600		
		Ø13 L > 600		
				

DOPPIO FILETTO - TESTA CILINDRICA

	DGZ	all		
---	-----	-----	---	---

(*)punta SHARP SAW NIBS (tipo RBSN)

La sostituzione completa delle punte 3 THORNS e SELF-DRILLING avverrà entro il 2026.

Per informazioni riguardo alla disponibilità dei codici di viti con punte specifiche, contattare il Tecnico Commerciale di riferimento.

DISTANZE MINIME PER VITI SOLLECITATE A TAGLIO | LEGNO

PUNTE A CONFRONTO: SHARP 1 CUT, 3 THORNS e SELF-DRILLING

● viti inserite **SENZA** preforo $\rho_k \leq 420 \text{ kg/m}^3$

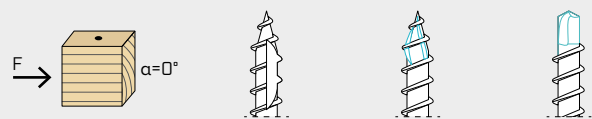

a_1	12·d	10·d	12·d
a_2	5·d	5·d	5·d
$a_{3,t}$	15·d	15·d	15·d
$a_{3,c}$	10·d	10·d	10·d
$a_{4,t}$	5·d	5·d	5·d
$a_{4,c}$	5·d	5·d	5·d

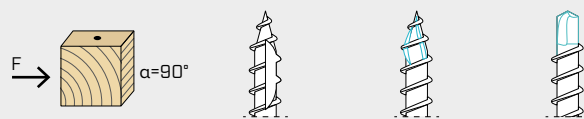

a_1	5·d	5·d	5·d
a_2	5·d	5·d	5·d
$a_{3,t}$	10·d	10·d	10·d
$a_{3,c}$	10·d	10·d	10·d
$a_{4,t}$	10·d	10·d	10·d
$a_{4,c}$	5·d	5·d	5·d

● viti inserite **SENZA** preforo $420 \text{ kg/m}^3 < \rho_k \leq 500 \text{ kg/m}^3$

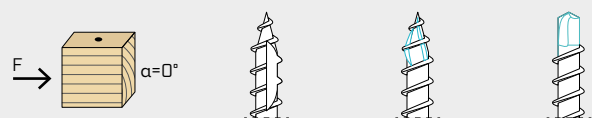

a_1	15·d	15·d	15·d
a_2	7·d	7·d	7·d
$a_{3,t}$	20·d	20·d	20·d
$a_{3,c}$	15·d	15·d	15·d
$a_{4,t}$	7·d	7·d	7·d
$a_{4,c}$	7·d	7·d	7·d

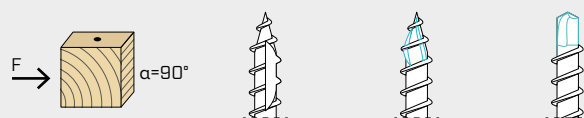

a_1	7·d	5·d	5·d
a_2	7·d	5·d	5·d
$a_{3,t}$	15·d	10·d	10·d
$a_{3,c}$	15·d	10·d	10·d
$a_{4,t}$	12·d	10·d	10·d
$a_{4,c}$	7·d	5·d	5·d

∩ viti inserite **CON** preforo

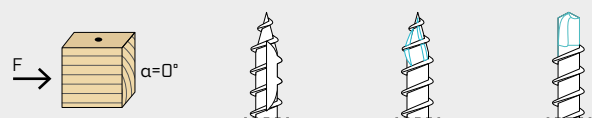

a_1	5·d	5·d	5·d
a_2	3·d	3·d	3·d
$a_{3,t}$	12·d	12·d	12·d
$a_{3,c}$	7·d	7·d	7·d
$a_{4,t}$	3·d	3·d	3·d
$a_{4,c}$	3·d	3·d	3·d

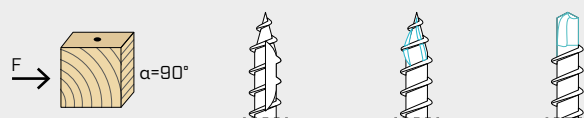

a_1	4·d	4·d	4·d
a_2	4·d	4·d	4·d
$a_{3,t}$	7·d	7·d	7·d
$a_{3,c}$	7·d	7·d	7·d
$a_{4,t}$	7·d	7·d	7·d
$a_{4,c}$	3·d	3·d	3·d

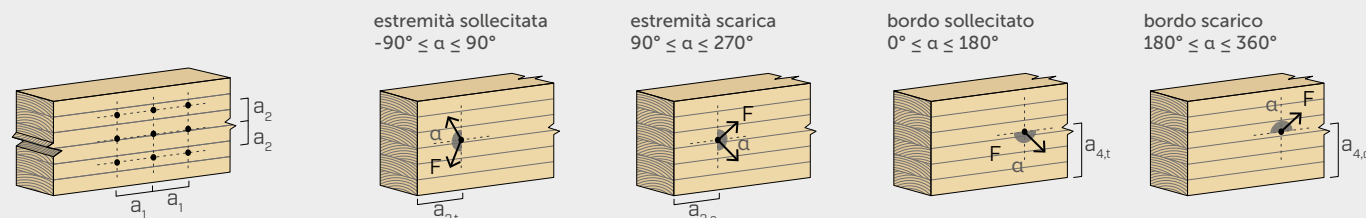

NOTE: si veda pagina 5.

LEGENDA



punta standard
SHARP 1 CUT
tipo RBN / RBN2



punta
3 THORNS
tipo RB3T

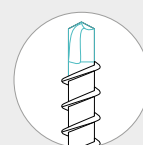

punta
SELF-DRILLING
tipo RBSD

(in graduale transizione verso 3 THORNS e SELF-DRILLING)

(disponibile a partire da **primavera 2024**)

(disponibile a partire da **primavera 2024**)

DISTANZE MINIME PER VITI SOLLECITATE A TAGLIO | ACCIAIO-LEGNO

PUNTE A CONFRONTO: SHARP 1 CUT, 3 THORNS e SELF-DRILLING

● viti inserite **SENZA** preforo $\rho_k \leq 420 \text{ kg/m}^3$

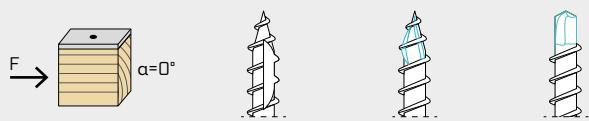

a_1	12-d-0,7	12-d-0,7	12-d-0,7
a_2	5-d-0,7	5-d-0,7	5-d-0,7
$a_{3,t}$	15-d	15-d	15-d
$a_{3,c}$	10-d	10-d	10-d
$a_{4,t}$	5-d	5-d	5-d
$a_{4,c}$	5-d	5-d	5-d



a_1	5-d-0,7	5-d-0,7	5-d-0,7
a_2	5-d-0,7	5-d-0,7	5-d-0,7
$a_{3,t}$	10-d	10-d	10-d
$a_{3,c}$	10-d	10-d	10-d
$a_{4,t}$	10-d	10-d	10-d
$a_{4,c}$	5-d	5-d	5-d

● viti inserite **SENZA** preforo $420 \text{ kg/m}^3 < \rho_k \leq 500 \text{ kg/m}^3$

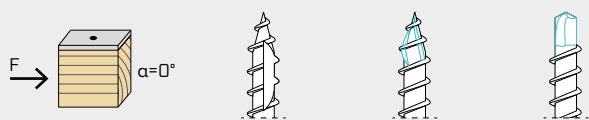

a_1	15-d-0,7	15-d-0,7	15-d-0,7
a_2	7-d-0,7	7-d-0,7	7-d-0,7
$a_{3,t}$	20-d	20-d	20-d
$a_{3,c}$	15-d	15-d	15-d
$a_{4,t}$	7-d	7-d	7-d
$a_{4,c}$	7-d	7-d	7-d

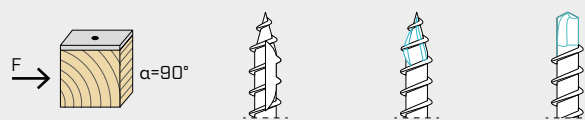

a_1	7-d-0,7	7-d-0,7	7-d-0,7
a_2	7-d-0,7	7-d-0,7	7-d-0,7
$a_{3,t}$	15-d	10-d	10-d
$a_{3,c}$	15-d	10-d	10-d
$a_{4,t}$	12-d	10-d	10-d
$a_{4,c}$	7-d	5-d	5-d

◐ viti inserite **CON** preforo

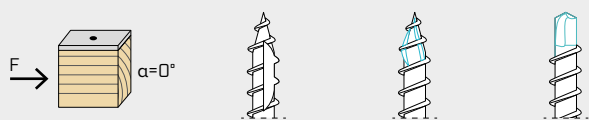

a_1	5-d-0,7	5-d-0,7	5-d-0,7
a_2	3-d-0,7	3-d-0,7	3-d-0,7
$a_{3,t}$	12-d	12-d	12-d
$a_{3,c}$	7-d	7-d	7-d
$a_{4,t}$	3-d	3-d	3-d
$a_{4,c}$	3-d	3-d	3-d

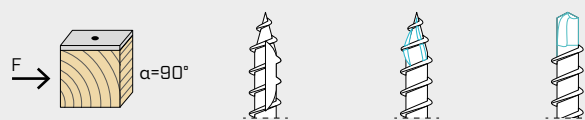

a_1	4-d-0,7	4-d-0,7	4-d-0,7
a_2	4-d-0,7	4-d-0,7	4-d-0,7
$a_{3,t}$	7-d	7-d	7-d
$a_{3,c}$	7-d	7-d	7-d
$a_{4,t}$	7-d	7-d	7-d
$a_{4,c}$	3-d	3-d	3-d

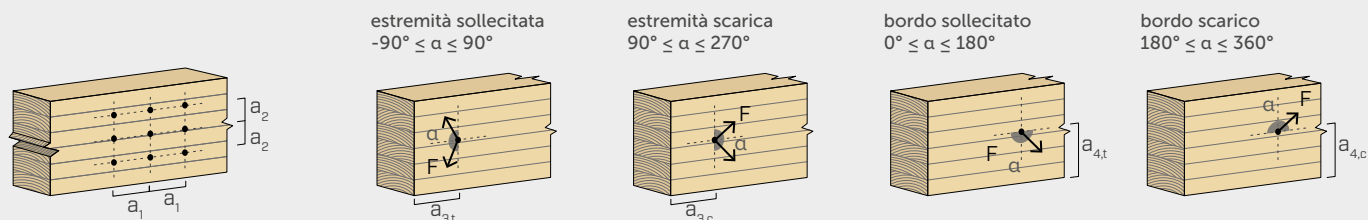

NOTE

- Le distanze minime sono secondo normativa EN 1995:2014 in accordo a ETA-11/0030.
- Le distanze minime sono valide per viti con $d_1 \geq 5 \text{ mm}$.
- Le distanze tabellate sono riferite a viti inserite in elementi in softwood (legno massiccio o lamellare). Per applicazioni su materiali differenti (es. CLT, LVL), si rimanda ad ETA-11/0030.
- La spaziatura a_1 tabellata per viti con punta 3 THORNS in connessioni legno-legno inserite senza preforo in elementi in legno con densità $\rho_k \leq 420 \text{ kg/m}^3$ con altezza e larghezza minime pari a 10-d ed angolo tra forza e fibre

$\alpha = 0^\circ$ si è assunta pari a 10-d. In alternativa, adottare 12-d in accordo a EN 1995:2014.

- La spaziatura a_1 tabellata per viti con punta SHARP 1 CUT/SELF-DRILLING inserite senza preforo in elementi in legno con densità $\rho_k \leq 420 \text{ kg/m}^3$ ed angolo tra forza e fibre $\alpha = 0^\circ$ si è assunta pari a 12-d in accordo a EN 1995:2014.

DISTANZE MINIME PER VITI SOLLECITATE A TAGLIO | LEGNO

VITI FILETTO PARZIALE

SHS - SHS AISI 410 - HBS - HBS EVO
TBS - TBS MAX - TBS EVO
HBS PLATE - HBS PLATE EVO - KKF

SHARP 1 CUT



viti inserite **SENZA** preforo

$\rho_k \leq 420 \text{ kg/m}^3$

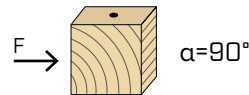
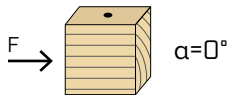

d_1 [mm]		3,5	4	4,5		5	6	8	10	12
a_1 [mm]	10·d	35	40	45	12·d	60	72	96	120	144
a_2 [mm]	5·d	18	20	23	5·d	25	30	40	50	60
$a_{3,t}$ [mm]	15·d	53	60	68	15·d	75	90	120	150	180
$a_{3,c}$ [mm]	10·d	35	40	45	10·d	50	60	80	100	120
$a_{4,t}$ [mm]	5·d	18	20	23	5·d	25	30	40	50	60
$a_{4,c}$ [mm]	5·d	18	20	23	5·d	25	30	40	50	60

d_1 [mm]		3,5	4	4,5		5	6	8	10	12
a_1 [mm]	5·d	18	20	23	5·d	25	30	40	50	60
a_2 [mm]	5·d	18	20	23	5·d	25	30	40	50	60
$a_{3,t}$ [mm]	10·d	35	40	45	10·d	50	60	80	100	120
$a_{3,c}$ [mm]	10·d	35	40	45	10·d	50	60	80	100	120
$a_{4,t}$ [mm]	7·d	25	28	32	10·d	50	60	80	100	120
$a_{4,c}$ [mm]	5·d	18	20	23	5·d	25	30	40	50	60

viti inserite **SENZA** preforo

$420 \text{ kg/m}^3 < \rho_k \leq 500 \text{ kg/m}^3$

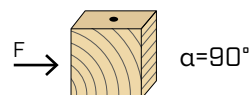
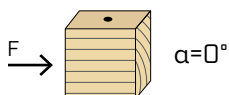

d_1 [mm]		3,5	4	4,5		5	6	8	10	12
a_1 [mm]	15·d	53	60	68	15·d	75	90	120	150	180
a_2 [mm]	7·d	25	28	32	7·d	35	42	56	70	84
$a_{3,t}$ [mm]	20·d	70	80	90	20·d	100	120	160	200	240
$a_{3,c}$ [mm]	15·d	53	60	68	15·d	75	90	120	150	180
$a_{4,t}$ [mm]	7·d	25	28	32	7·d	35	42	56	70	84
$a_{4,c}$ [mm]	7·d	25	28	32	7·d	35	42	56	70	84

d_1 [mm]		3,5	4	4,5		5	6	8	10	12
a_1 [mm]	7·d	25	28	32	7·d	35	42	56	70	84
a_2 [mm]	7·d	25	28	32	7·d	35	42	56	70	84
$a_{3,t}$ [mm]	15·d	53	60	68	15·d	75	90	120	150	180
$a_{3,c}$ [mm]	15·d	53	60	68	15·d	75	90	120	150	180
$a_{4,t}$ [mm]	9·d	32	36	41	12·d	60	72	96	120	144
$a_{4,c}$ [mm]	7·d	25	28	32	7·d	35	42	56	70	84

viti inserite **CON** preforo

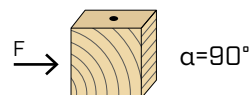
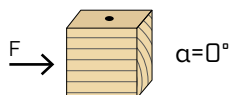

d_1 [mm]		3,5	4	4,5		5	6	8	10	12
a_1 [mm]	5·d	18	20	23	5·d	25	30	40	50	60
a_2 [mm]	3·d	11	12	14	3·d	15	18	24	30	36
$a_{3,t}$ [mm]	12·d	42	48	54	12·d	60	72	96	120	144
$a_{3,c}$ [mm]	7·d	25	28	32	7·d	35	42	56	70	84
$a_{4,t}$ [mm]	3·d	11	12	14	3·d	15	18	24	30	36
$a_{4,c}$ [mm]	3·d	11	12	14	3·d	15	18	24	30	36

d_1 [mm]		3,5	4	4,5		5	6	8	10	12
a_1 [mm]	4·d	14	16	18	4·d	20	24	32	40	48
a_2 [mm]	4·d	14	16	18	4·d	20	24	32	40	48
$a_{3,t}$ [mm]	7·d	25	28	32	7·d	35	42	56	70	84
$a_{3,c}$ [mm]	7·d	25	28	32	7·d	35	42	56	70	84
$a_{4,t}$ [mm]	5·d	18	20	23	7·d	35	42	56	70	84
$a_{4,c}$ [mm]	3·d	11	12	14	3·d	15	18	24	30	36

α = angolo tra forza e fibre
 d = d_1 = diametro nominale vite

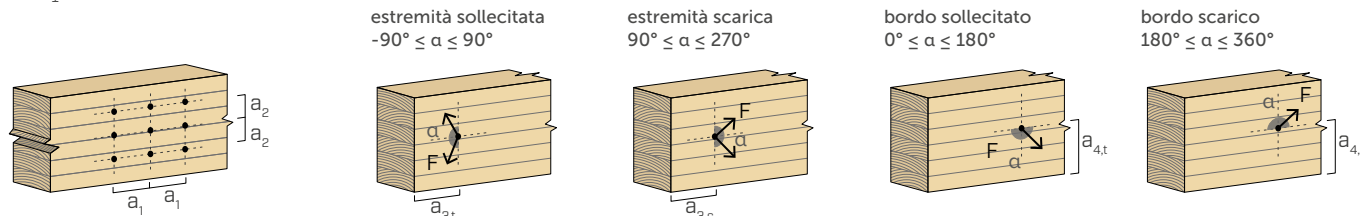

NOTE

- Le distanze minime sono secondo normativa EN 1995:2014 in accordo a ETA-11/0030.
- Nel caso di giunzione pannello-legno le spazature minime (a_1 , a_2) possono essere moltiplicate per un coefficiente 0,85.
- Nel caso di giunzioni con elementi di abete di Douglas (Pseudotsuga menziesii) le spazature e le distanze minime parallele alla fibra devono essere moltiplicate per un coefficiente 1,5.
- Le distanze tabellate sono riferite a viti con punta standard SHARP 1 CUT.
- Le distanze tabellate sono riferite a viti inserite in elementi in softwood (legno massiccio o lamellare). Per applicazioni su materiali differenti (es. CLT, LVL), si rimanda ad ETA-11/0030.

DISTANZE MINIME PER VITI SOLLECITATE A TAGLIO | LEGNO

VITI FILETTO PARZIALE

SHS - SHS AISI 410 - HBS - HBS EVO
TBS - TBS MAX - TBS EVO - TBS FRAME
HBS PLATE - HBS PLATE EVO - KKF

3 THORNS



viti inserite **SENZA** preforo $\rho_k \leq 420 \text{ kg/m}^3$

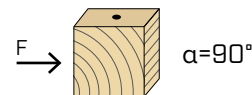
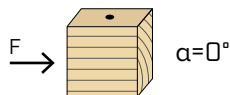

d_1 [mm]		3,5	4	4,5		5	6	8	10	12
a_1 [mm]	10-d	35	40	45	10-d	50	60	80	100	120
a_2 [mm]	5-d	18	20	23	5-d	25	30	40	50	60
$a_{3,t}$ [mm]	15-d	53	60	68	15-d	75	90	120	150	180
$a_{3,c}$ [mm]	10-d	35	40	45	10-d	50	60	80	100	120
$a_{4,t}$ [mm]	5-d	18	20	23	5-d	25	30	40	50	60
$a_{4,c}$ [mm]	5-d	18	20	23	5-d	25	30	40	50	60

d_1 [mm]		3,5	4	4,5		5	6	8	10	12
a_1 [mm]	5-d	18	20	23	5-d	25	30	40	50	60
a_2 [mm]	5-d	18	20	23	5-d	25	30	40	50	60
$a_{3,t}$ [mm]	10-d	35	40	45	10-d	50	60	80	100	120
$a_{3,c}$ [mm]	10-d	35	40	45	10-d	50	60	80	100	120
$a_{4,t}$ [mm]	7-d	25	28	32	10-d	50	60	80	100	120
$a_{4,c}$ [mm]	5-d	18	20	23	5-d	25	30	40	50	60

viti inserite **SENZA** preforo $420 \text{ kg/m}^3 < \rho_k \leq 500 \text{ kg/m}^3$

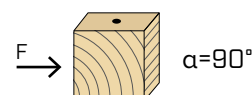
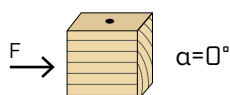

d_1 [mm]		3,5	4	4,5		5	6	8	10	12
a_1 [mm]	15-d	53	60	68	15-d	75	90	120	150	180
a_2 [mm]	7-d	25	28	32	7-d	35	42	56	70	84
$a_{3,t}$ [mm]	20-d	70	80	90	20-d	100	120	160	200	240
$a_{3,c}$ [mm]	15-d	53	60	68	15-d	75	90	120	150	180
$a_{4,t}$ [mm]	7-d	25	28	32	7-d	35	42	56	70	84
$a_{4,c}$ [mm]	7-d	25	28	32	7-d	35	42	56	70	84

d_1 [mm]		3,5	4	4,5		5	6	8	10	12
a_1 [mm]	7-d	25	28	32	7-d	35	42	56	70	84
a_2 [mm]	7-d	25	28	32	7-d	35	42	56	70	84
$a_{3,t}$ [mm]	15-d	53	60	68	15-d	75	90	120	150	180
$a_{3,c}$ [mm]	15-d	53	60	68	15-d	75	90	120	150	180
$a_{4,t}$ [mm]	9-d	32	36	41	12-d	60	72	96	120	144
$a_{4,c}$ [mm]	7-d	25	28	32	7-d	35	42	56	70	84

viti inserite **CON** preforo

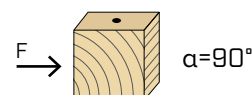
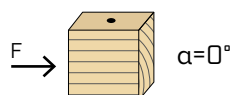

d_1 [mm]		3,5	4	4,5		5	6	8	10	12
a_1 [mm]	5-d	18	20	23	5-d	25	30	40	50	60
a_2 [mm]	3-d	11	12	14	3-d	15	18	24	30	36
$a_{3,t}$ [mm]	12-d	42	48	54	12-d	60	72	96	120	144
$a_{3,c}$ [mm]	7-d	25	28	32	7-d	35	42	56	70	84
$a_{4,t}$ [mm]	3-d	11	12	14	3-d	15	18	24	30	36
$a_{4,c}$ [mm]	3-d	11	12	14	3-d	15	18	24	30	36

d_1 [mm]		3,5	4	4,5		5	6	8	10	12
a_1 [mm]	4-d	14	16	18	4-d	20	24	32	40	48
a_2 [mm]	4-d	14	16	18	4-d	20	24	32	40	48
$a_{3,t}$ [mm]	7-d	25	28	32	7-d	35	42	56	70	84
$a_{3,c}$ [mm]	7-d	25	28	32	7-d	35	42	56	70	84
$a_{4,t}$ [mm]	5-d	18	20	23	7-d	35	42	56	70	84
$a_{4,c}$ [mm]	3-d	11	12	14	3-d	15	18	24	30	36

α = angolo tra forza e fibre
 d = d_1 = diametro nominale vite

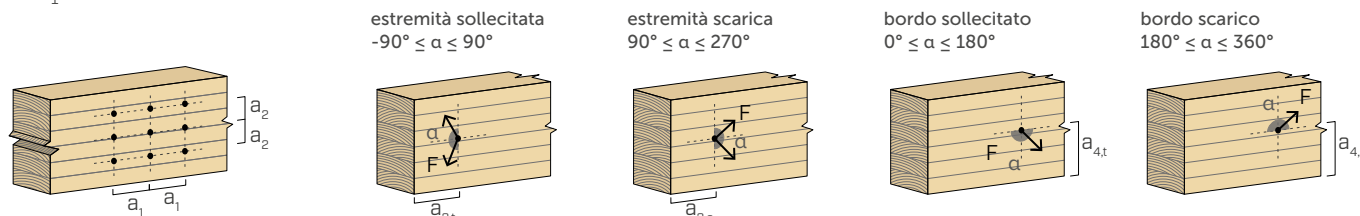

NOTE

- Le distanze minime sono secondo normativa EN 1995:2014 in accordo a ETA-11/0030.
- Nel caso di giunzione pannello-legno le spazature minime (a_1 , a_2) possono essere moltiplicate per un coefficiente 0,85.
- Nel caso di giunzioni con elementi di abete di Douglas (Pseudotsuga menziesii) le spazature e le distanze minime parallele alla fibra devono essere moltiplicate per un coefficiente 1,5.
- Le distanze tabellate sono riferite a viti con punta 3 THORNS.

- La spaziatura a_1 per viti inserite senza preforo in elementi in legno con densità $\rho_k \leq 420 \text{ kg/m}^3$ con altezza e larghezza minime pari a $10 \cdot d$ ed angolo tra forza e fibre $\alpha = 0^\circ$ si è assunta pari a $10 \cdot d$. In alternativa, adottare $12 \cdot d$ in accordo a EN 1995:2014.
- Le distanze tabellate sono riferite a viti inserite in elementi in softwood (legno massiccio o lamellare). Per applicazioni su materiali differenti (es. CLT, LVL), si rimanda ad ETA-11/0030.

DISTANZE MINIME PER VITI SOLLECITATE A TAGLIO | ACCIAIO - LEGNO

VITI FILETTO PARZIALE

HBS - HBS EVO
HBS PLATE - HBS PLATE EVO - KKF

SHARP 1 CUT



viti inserite **SENZA** preforo $\rho_k \leq 420 \text{ kg/m}^3$

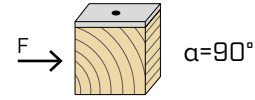
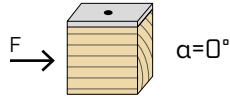

d_1 [mm]		3,5	4	4,5		5	6	8	10	12
a_1 [mm]	10-d-0,7	25	28	32	12-d-0,7	42	50	67	84	101
a_2 [mm]	5-d-0,7	12	14	16	5-d-0,7	18	21	28	35	42
$a_{3,t}$ [mm]	15-d	53	60	68	15-d	75	90	120	150	180
$a_{3,c}$ [mm]	10-d	35	40	45	10-d	50	60	80	100	120
$a_{4,t}$ [mm]	5-d	18	20	23	5-d	25	30	40	50	60
$a_{4,c}$ [mm]	5-d	18	20	23	5-d	25	30	40	50	60

d_1 [mm]		3,5	4	4,5		5	6	8	10	12
a_1 [mm]	5-d-0,7	12	14	16	5-d-0,7	18	21	28	35	42
a_2 [mm]	5-d-0,7	12	14	16	5-d-0,7	18	21	28	35	42
$a_{3,t}$ [mm]	10-d	35	40	45	10-d	50	60	80	100	120
$a_{3,c}$ [mm]	10-d	35	40	45	10-d	50	60	80	100	120
$a_{4,t}$ [mm]	7-d	25	28	32	10-d	50	60	80	100	120
$a_{4,c}$ [mm]	5-d	18	20	23	5-d	25	30	40	50	60

viti inserite **SENZA** preforo $420 \text{ kg/m}^3 < \rho_k \leq 500 \text{ kg/m}^3$

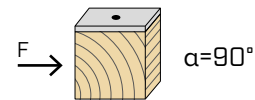
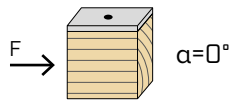

d_1 [mm]		3,5	4	4,5		5	6	8	10	12
a_1 [mm]	15-d-0,7	37	42	47	15-d-0,7	53	63	84	105	126
a_2 [mm]	7-d-0,7	17	20	22	7-d-0,7	25	29	39	49	59
$a_{3,t}$ [mm]	20-d	70	80	90	20-d	100	120	160	200	240
$a_{3,c}$ [mm]	15-d	53	60	68	15-d	75	90	120	150	180
$a_{4,t}$ [mm]	7-d	25	28	32	7-d	35	42	56	70	84
$a_{4,c}$ [mm]	7-d	25	28	32	7-d	35	42	56	70	84

d_1 [mm]		3,5	4	4,5		5	6	8	10	12
a_1 [mm]	7-d-0,7	17	20	22	7-d-0,7	25	29	39	49	59
a_2 [mm]	7-d-0,7	17	20	22	7-d-0,7	25	29	39	49	59
$a_{3,t}$ [mm]	15-d	53	60	68	15-d	75	90	120	150	180
$a_{3,c}$ [mm]	15-d	53	60	68	15-d	75	90	120	150	180
$a_{4,t}$ [mm]	9-d	32	36	41	12-d	60	72	96	120	144
$a_{4,c}$ [mm]	7-d	25	28	32	7-d	35	42	56	70	84

viti inserite **CON** preforo

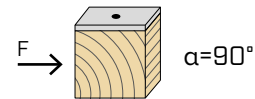
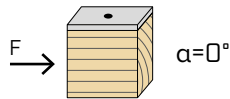

d_1 [mm]		3,5	4	4,5		5	6	8	10	12
a_1 [mm]	5-d-0,7	12	14	16	5-d-0,7	18	21	28	35	42
a_2 [mm]	3-d-0,7	7	8	9	3-d-0,7	11	13	17	21	25
$a_{3,t}$ [mm]	12-d	42	48	54	12-d	60	72	96	120	144
$a_{3,c}$ [mm]	7-d	25	28	32	7-d	35	42	56	70	84
$a_{4,t}$ [mm]	3-d	11	12	14	3-d	15	18	24	30	36
$a_{4,c}$ [mm]	3-d	11	12	14	3-d	15	18	24	30	36

d_1 [mm]		3,5	4	4,5		5	6	8	10	12
a_1 [mm]	4-d-0,7	10	11	13	4-d-0,7	14	17	22	28	34
a_2 [mm]	4-d-0,7	10	11	13	4-d-0,7	14	17	22	28	34
$a_{3,t}$ [mm]	7-d	25	28	32	7-d	35	42	56	70	84
$a_{3,c}$ [mm]	7-d	25	28	32	7-d	35	42	56	70	84
$a_{4,t}$ [mm]	5-d	18	20	23	7-d	35	42	56	70	84
$a_{4,c}$ [mm]	3-d	11	12	14	3-d	15	18	24	30	36

α = angolo tra forza e fibre
 d = d_1 = diametro nominale vite

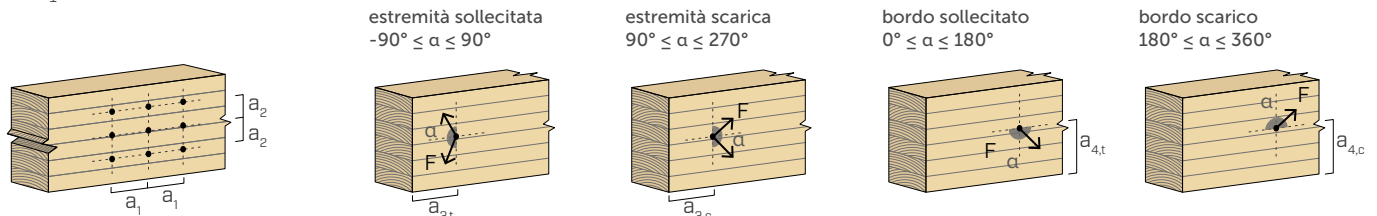

NOTE

- Le distanze minime sono secondo normativa EN 1995:2014 in accordo a ETA-11/0030.
- Nel caso di giunzioni con elementi di abete di Douglas (Pseudotsuga menziesii) le spaziature e le distanze minime parallele alla fibra devono essere moltiplicate per un coefficiente 1,5.
- Le distanze tabellate sono riferite a viti con punta standard SHARP 1 CUT.
- Le distanze tabellate sono riferite a viti inserite in elementi in softwood (legno massiccio o lamellare). Per applicazioni su materiali differenti (es. CLT, LVL), si rimanda ad ETA-11/0030.

DISTANZE MINIME PER VITI SOLLECITATE A TAGLIO | ACCIAIO - LEGNO

VITI FILETTO PARZIALE

HBS - HBS EVO
HBS PLATE - HBS PLATE EVO - KKF

3 THORNS



viti inserite **SENZA** preforo $\rho_k \leq 420 \text{ kg/m}^3$

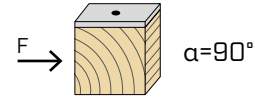
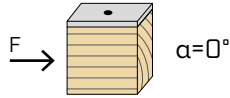

d_1 [mm]	3,5	4	4,5	5	6	8	10	12
a_1 [mm]	10·d-0,7	25	28	12·d-0,7	42	50	67	84
a_2 [mm]	5·d-0,7	12	14	5·d-0,7	18	21	28	35
$a_{3,t}$ [mm]	15·d	53	60	15·d	75	90	120	150
$a_{3,c}$ [mm]	10·d	35	40	10·d	50	60	80	100
$a_{4,t}$ [mm]	5·d	18	20	5·d	25	30	40	50
$a_{4,c}$ [mm]	5·d	18	20	5·d	25	30	40	50

d_1 [mm]	3,5	4	4,5	5	6	8	10	12
a_1 [mm]	5·d-0,7	12	14	5·d-0,7	18	21	28	35
a_2 [mm]	5·d-0,7	12	14	5·d-0,7	18	21	28	35
$a_{3,t}$ [mm]	10·d	35	40	10·d	50	60	80	100
$a_{3,c}$ [mm]	10·d	35	40	10·d	50	60	80	100
$a_{4,t}$ [mm]	7·d	25	28	10·d	50	60	80	100
$a_{4,c}$ [mm]	5·d	18	20	5·d	25	30	40	50

viti inserite **SENZA** preforo $420 \text{ kg/m}^3 < \rho_k \leq 500 \text{ kg/m}^3$

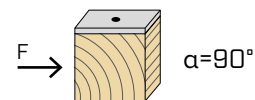
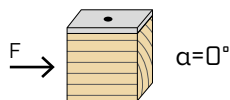

d_1 [mm]	3,5	4	4,5	5	6	8	10	12
a_1 [mm]	15·d-0,7	37	42	15·d-0,7	53	63	84	105
a_2 [mm]	7·d-0,7	17	20	7·d-0,7	25	29	39	49
$a_{3,t}$ [mm]	20·d	70	80	20·d	100	120	160	200
$a_{3,c}$ [mm]	15·d	53	60	15·d	75	90	120	150
$a_{4,t}$ [mm]	7·d	25	28	7·d	35	42	56	70
$a_{4,c}$ [mm]	7·d	25	28	7·d	35	42	56	70

d_1 [mm]	3,5	4	4,5	5	6	8	10	12
a_1 [mm]	7·d-0,7	17	20	7·d-0,7	25	29	39	49
a_2 [mm]	7·d-0,7	17	20	7·d-0,7	25	29	39	49
$a_{3,t}$ [mm]	15·d	53	60	15·d	75	90	120	150
$a_{3,c}$ [mm]	15·d	53	60	15·d	75	90	120	150
$a_{4,t}$ [mm]	9·d	32	36	12·d	60	72	96	120
$a_{4,c}$ [mm]	7·d	25	28	7·d	35	42	56	70

viti inserite **CON** preforo

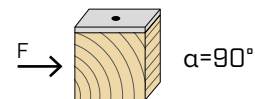
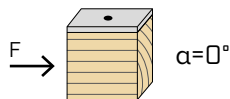

d_1 [mm]	3,5	4	4,5	5	6	8	10	12
a_1 [mm]	5·d-0,7	12	14	5·d-0,7	18	21	28	35
a_2 [mm]	3·d-0,7	7	8	3·d-0,7	11	13	17	21
$a_{3,t}$ [mm]	12·d	42	48	12·d	60	72	96	120
$a_{3,c}$ [mm]	7·d	25	28	7·d	35	42	56	70
$a_{4,t}$ [mm]	3·d	11	12	3·d	15	18	24	30
$a_{4,c}$ [mm]	3·d	11	12	3·d	15	18	24	30

d_1 [mm]	3,5	4	4,5	5	6	8	10	12
a_1 [mm]	4·d-0,7	10	11	4·d-0,7	14	17	22	28
a_2 [mm]	4·d-0,7	10	11	4·d-0,7	14	17	22	28
$a_{3,t}$ [mm]	7·d	25	28	7·d	35	42	56	70
$a_{3,c}$ [mm]	7·d	25	28	7·d	35	42	56	70
$a_{4,t}$ [mm]	5·d	18	20	7·d	35	42	56	70
$a_{4,c}$ [mm]	3·d	11	12	3·d	15	18	24	30

α = angolo tra forza e fibre
 d = d_1 = diametro nominale vite

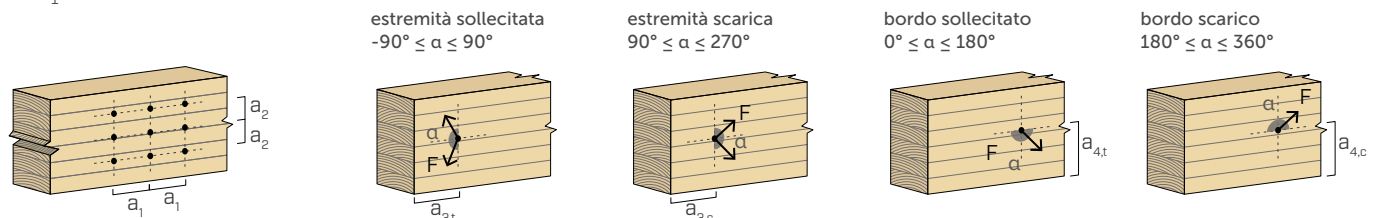

NOTE

- Le distanze minime sono secondo normativa EN 1995:2014 in accordo a ETA-11/0030.
- Nel caso di giunzioni con elementi di abete di Douglas (Pseudotsuga menziesii) le spazature e le distanze minime parallele alla fibra devono essere moltiplicate per un coefficiente 1,5.
- Le distanze tabellate sono riferite a viti con punta 3 THORNS.
- Le distanze tabellate sono riferite a viti inserite in elementi in softwood (legno massiccio o lamellare). Per applicazioni su materiali differenti (es. CLT, LVL), si rimanda ad ETA-11/0030.

DISTANZE MINIME PER VITI SOLLECITATE A TAGLIO | LEGNO

VITI FILETTO TOTALE

VGZ - VGZ EVO
VGS - VGS EVO

SHARP 1 CUT
SELF-DRILLING

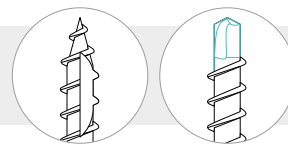

viti inserite **SENZA** preforo

$\rho_k \leq 420 \text{ kg/m}^3$

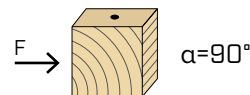
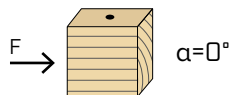

d_1 [mm]		5,3	5,6	7	9	11	13
a_1 [mm]	12-d	64	67	84	108	132	156
a_2 [mm]	5-d	27	28	35	45	55	65
$a_{3,t}$ [mm]	15-d	80	84	105	135	165	195
$a_{3,c}$ [mm]	10-d	53	56	70	90	110	130
$a_{4,t}$ [mm]	5-d	27	28	35	45	55	65
$a_{4,c}$ [mm]	5-d	27	28	35	45	55	65

d_1 [mm]		5,3	5,6	7	9	11	13
a_1 [mm]	5-d	27	28	35	45	55	65
a_2 [mm]	5-d	27	28	35	45	55	65
$a_{3,t}$ [mm]	10-d	53	56	70	90	110	130
$a_{3,c}$ [mm]	10-d	53	56	70	90	110	130
$a_{4,t}$ [mm]	10-d	53	56	70	90	110	130
$a_{4,c}$ [mm]	5-d	27	28	35	45	55	65

viti inserite **SENZA** preforo

$420 \text{ kg/m}^3 < \rho_k \leq 500 \text{ kg/m}^3$

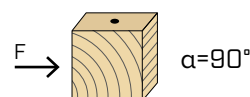
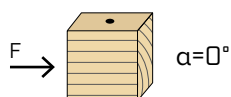

d_1 [mm]		5,3	5,6	7	9	11	13
a_1 [mm]	15-d	80	84	105	135	165	195
a_2 [mm]	7-d	37	39	49	63	77	91
$a_{3,t}$ [mm]	20-d	106	112	140	180	220	260
$a_{3,c}$ [mm]	15-d	80	84	105	135	165	195
$a_{4,t}$ [mm]	7-d	37	39	49	63	77	91
$a_{4,c}$ [mm]	7-d	37	39	49	63	77	91

d_1 [mm]		5,3	5,6	7	9	11	13
a_1 [mm]	7-d	37	39	49	63	77	91
a_2 [mm]	7-d	37	39	49	63	77	91
$a_{3,t}$ [mm]	15-d	80	84	105	135	165	195
$a_{3,c}$ [mm]	15-d	80	84	105	135	165	195
$a_{4,t}$ [mm]	12-d	64	67	84	108	132	156
$a_{4,c}$ [mm]	7-d	37	39	49	63	77	91

viti inserite **CON** preforo

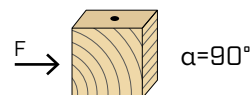
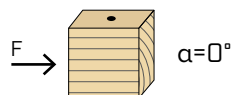

d_1 [mm]		5,3	5,6	7	9	11	13
a_1 [mm]	5-d	27	28	35	45	55	65
a_2 [mm]	3-d	16	17	21	27	33	39
$a_{3,t}$ [mm]	12-d	64	67	84	108	132	156
$a_{3,c}$ [mm]	7-d	37	39	49	63	77	91
$a_{4,t}$ [mm]	3-d	16	17	21	27	33	39
$a_{4,c}$ [mm]	3-d	16	17	21	27	33	39

d_1 [mm]		5,3	5,6	7	9	11	13
a_1 [mm]	4-d	21	22	28	36	44	52
a_2 [mm]	4-d	21	22	28	36	44	52
$a_{3,t}$ [mm]	7-d	37	39	49	63	77	91
$a_{3,c}$ [mm]	7-d	37	39	49	63	77	91
$a_{4,t}$ [mm]	7-d	37	39	49	63	77	91
$a_{4,c}$ [mm]	3-d	16	17	21	27	33	39

α = angolo tra forza e fibre
 d = d_1 = diametro nominale vite

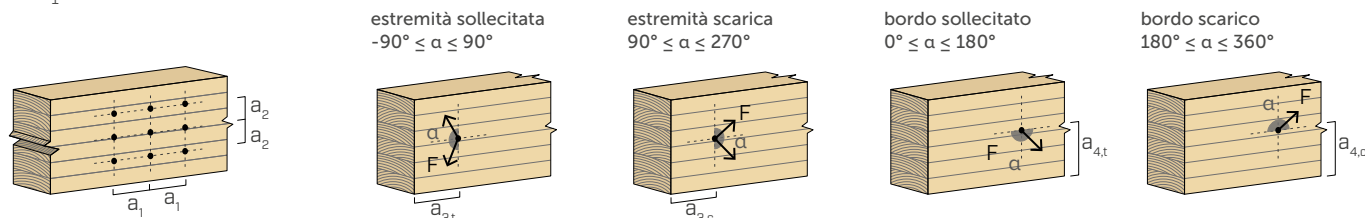

NOTE

- Le distanze tabellate sono secondo normativa EN 1995:2014 in accordo a ETA-11/0030.
- Nel caso di giunzione pannello-legno le spazature minime (a_1 , a_2) possono essere moltiplicate per un coefficiente 0,85.
- Nel caso di giunzioni con elementi di abete di Douglas (Pseudotsuga menziesii) le spazature e le distanze minime parallele alla fibra devono essere moltiplicate per un coefficiente 1,5.

- Le distanze tabellate sono riferite a viti con punta standard SHARP 1 CUT/SELF-DRILLING.
- Le distanze tabellate sono riferite a viti inserite in elementi in softwood (legno massiccio o lamellare). Per applicazioni su materiali differenti (es. CLT, LVL), si rimanda ad ETA-11/0030.

DISTANZE MINIME PER VITI SOLLECITATE A TAGLIO | LEGNO

VITI FILETTO TOTALE

VGZ - VGZ EVO
VGS - VGS EVO

3 THORNS



viti inserite **SENZA** preforo $\rho_k \leq 420 \text{ kg/m}^3$

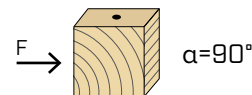
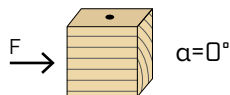

d_1 [mm]		5,3	5,6	7	9	11	13
a_1 [mm]	10-d	53	56	70	90	110	130
a_2 [mm]	5-d	27	28	35	45	55	65
$a_{3,t}$ [mm]	15-d	80	84	105	135	165	195
$a_{3,c}$ [mm]	10-d	53	56	70	90	110	130
$a_{4,t}$ [mm]	5-d	27	28	35	45	55	65
$a_{4,c}$ [mm]	5-d	27	28	35	45	55	65

d_1 [mm]		5,3	5,6	7	9	11	13
a_1 [mm]	5-d	27	28	35	45	55	65
a_2 [mm]	5-d	27	28	35	45	55	65
$a_{3,t}$ [mm]	10-d	53	56	70	90	110	130
$a_{3,c}$ [mm]	10-d	53	56	70	90	110	130
$a_{4,t}$ [mm]	10-d	53	56	70	90	110	130
$a_{4,c}$ [mm]	5-d	27	28	35	45	55	65

viti inserite **SENZA** preforo $420 \text{ kg/m}^3 < \rho_k \leq 500 \text{ kg/m}^3$

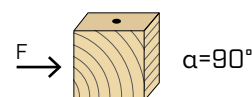
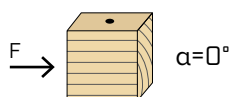

d_1 [mm]		5,3	5,6	7	9	11	13
a_1 [mm]	15-d	80	84	105	135	165	195
a_2 [mm]	7-d	37	39	49	63	77	91
$a_{3,t}$ [mm]	20-d	106	112	140	180	220	260
$a_{3,c}$ [mm]	15-d	80	84	105	135	165	195
$a_{4,t}$ [mm]	7-d	37	39	49	63	77	91
$a_{4,c}$ [mm]	7-d	37	39	49	63	77	91

d_1 [mm]		5,3	5,6	7	9	11	13
a_1 [mm]	7-d	37	39	49	63	77	91
a_2 [mm]	7-d	37	39	49	63	77	91
$a_{3,t}$ [mm]	15-d	80	84	105	135	165	195
$a_{3,c}$ [mm]	15-d	80	84	105	135	165	195
$a_{4,t}$ [mm]	12-d	64	67	84	108	132	156
$a_{4,c}$ [mm]	7-d	37	39	49	63	77	91

viti inserite **CON** preforo

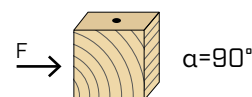
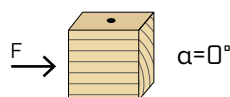

d_1 [mm]		5,3	5,6	7	9	11	13
a_1 [mm]	5-d	27	28	35	45	55	65
a_2 [mm]	3-d	16	17	21	27	33	39
$a_{3,t}$ [mm]	12-d	64	67	84	108	132	156
$a_{3,c}$ [mm]	7-d	37	39	49	63	77	91
$a_{4,t}$ [mm]	3-d	16	17	21	27	33	39
$a_{4,c}$ [mm]	3-d	16	17	21	27	33	39

d_1 [mm]		5,3	5,6	7	9	11	13
a_1 [mm]	4-d	21	22	28	36	44	52
a_2 [mm]	4-d	21	22	28	36	44	52
$a_{3,t}$ [mm]	7-d	37	39	49	63	77	91
$a_{3,c}$ [mm]	7-d	37	39	49	63	77	91
$a_{4,t}$ [mm]	7-d	37	39	49	63	77	91
$a_{4,c}$ [mm]	3-d	16	17	21	27	33	39

α = angolo tra forza e fibre
 d = d_1 = diametro nominale vite

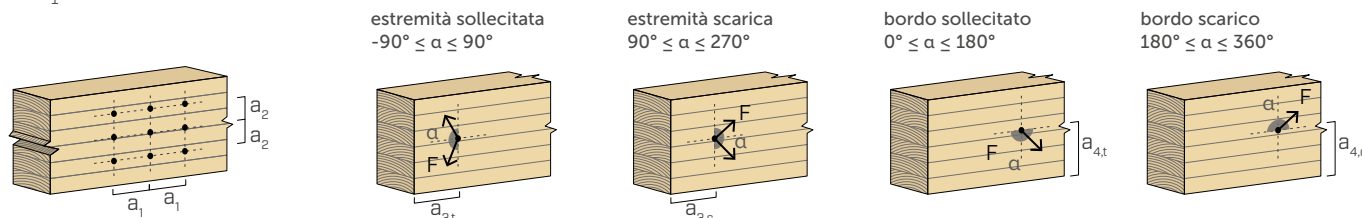

NOTE

- Le distanze minime sono secondo normativa EN 1995:2014 in accordo a ETA-11/0030.
- Nel caso di giunzioni pannello-legno le spazature minime (a_1 , a_2) possono essere moltiplicate per un coefficiente 0,85.
- Nel caso di giunzioni con elementi di abete di Douglas (Pseudotsuga menziesii) le spazature e le distanze minime parallele alla fibra devono essere moltiplicate per un coefficiente 1,5.
- Le distanze tabellate sono riferite a viti con punta 3 THORNS.
- La spaziatura a_1 per viti inserite senza preforo in elementi in legno con densità $\rho_k \leq 420 \text{ kg/m}^3$ con altezza e larghezza minime pari a 10-d ed angolo tra forza e fibre $\alpha = 0^\circ$ si è assunta pari a 10-d. In alternativa, adottare 12-d in accordo a EN 1995:2014.
- Le distanze tabellate sono riferite a viti inserite in elementi in softwood (legno massiccio o lamellare). Per applicazioni su materiali differenti (es. CLT, LVL), si rimanda ad ETA-11/0030.

DISTANZE MINIME PER VITI SOLLECITATE ASSIALMENTE | LEGNO

PUNTE A CONFRONTO: SHARP 1 CUT, 3 THORNS e SELF-DRILLING

 viti inserite CON e SENZA preforo

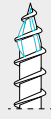
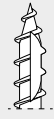

a_1	5-d	5-d	5-d
a_2	5-d	5-d	5-d
$a_{2,LIM}$	3-d	3-d	3-d
$a_{1,CG}$	10-d	10-d	10-d
$a_{2,CG}$	4-d	4-d	4-d
a_{CROSS}	1,5-d	1,5-d	1,5-d

VITI IN TRAZIONE INSERITE CON UN ANGOLO α RISPETTO ALLA FIBRA

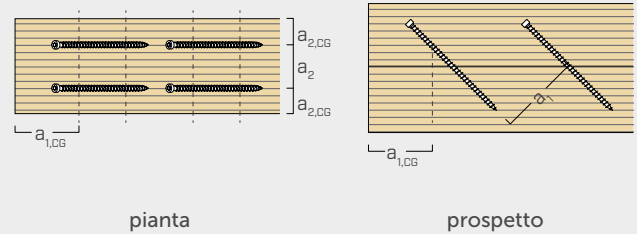
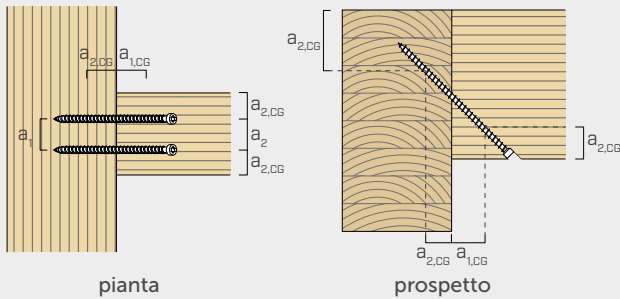

VITI INSERITE CON UN ANGOLO $\alpha = 90^\circ$ RISPETTO ALLA FIBRA

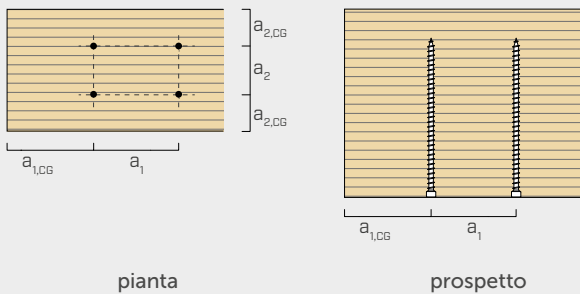

VITI INCROCIATE INSERITE CON UN ANGOLO α RISPETTO ALLA FIBRA

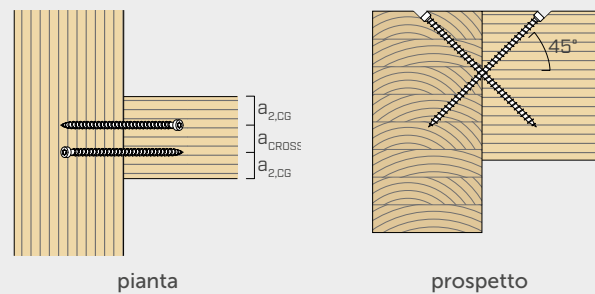

NOTE

- Le distanze minime sono secondo normativa EN 1995:2014 in accordo a ETA-11/0030.
- Le distanze minime sono indipendenti dall'angolo di inserimento del connettore e dall'angolo della forza rispetto alla fibra.
- La distanza assiale a_2 può essere ridotta fino ad $a_{2,LIM}$ se per ogni connettore viene mantenuta una "superficie di giunzione" $a_1 \cdot a_2 = 25 \cdot d_1$.
- Per giunzioni trave secondaria-trave principale con viti VGZ $d = 7$ mm inclinate o incrociate verso 3 THORNS e SELF-DRILLING, inserite con angolo di 45° rispetto alla testa della trave secondaria, con un'altezza minima della trave secondaria pari a $18 \cdot d$, la distanza minima $a_{1,CG}$ può essere assunta pari a $8 \cdot d_1$ e la distanza minima $a_{2,CG}$ pari a $3 \cdot d_1$.
- Le distanze tabellate sono riferite a viti inserite in elementi in softwood (legno massiccio o lamellare). Per applicazioni su materiali differenti (es. CLT, LVL) si rimanda ad ETA-11/0030.

LEGENDA



punta standard
SHARP 1 CUT
tipo RBN / RBN2



punta
3 THORNS
tipo RB3T



punta
SELF-DRILLING
tipo RBSD

(in graduale transizione verso 3 THORNS e SELF-DRILLING)

(disponibile a partire da **primavera 2024**)

(disponibile a partire da **primavera 2024**)

DISTANZE MINIME PER VITI SOLLECITATE ASSIALMENTE | LEGNO

VITI FILETTO TOTALE

VGZ - VGZ EVO
VGS - VGS EVO

SHARP 1 CUT

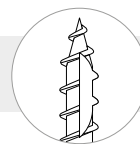

viti inserite CON e SENZA preforo

d ₁	[mm]		5,3	5,6	7	9	11	13
a ₁	[mm]	5·d	27	28	35	45	55	65
a ₂	[mm]	5·d	27	28	35	45	55	65
a _{2,LIM}	[mm]	2,5·d	13	14	18	23	28	33
a _{1,CG}	[mm]	10·d	53	56	70	90	110	130
a _{2,CG}	[mm]	4·d	21	22	28	36	44	52
a _{CROSS}	[mm]	1,5·d	8	8	11	14	17	20

VITI FILETTO TOTALE

VGZ - VGZ EVO
VGS - VGS EVO

3 THORNS



viti inserite CON e SENZA preforo

d ₁	[mm]		5,3	5,6	7	9	11	13
a ₁	[mm]	5·d	27	28	35	45	55	65
a ₂	[mm]	5·d	27	28	35	45	55	65
a _{2,LIM}	[mm]	2,5·d	13	14	18	23	28	33
a _{1,CG}	[mm]	10·d	53	56	70	90	110	130
a _{2,CG}	[mm]	4·d	21	22	28	36	44	52
a _{CROSS}	[mm]	1,5·d	8	8	11	14	17	20

VITI FILETTO TOTALE

VGZ - VGZ EVO
VGS - VGS EVO

SELF-DRILLING

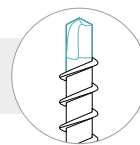

viti inserite CON e SENZA preforo

d ₁	[mm]		9	11	13
a ₁	[mm]	5·d	45	55	65
a ₂	[mm]	5·d	45	55	65
a _{2,LIM}	[mm]	2,5·d	23	28	33
a _{1,CG}	[mm]	10·d	90	110	130
a _{2,CG}	[mm]	4·d	36	44	52
a _{CROSS}	[mm]	1,5·d	14	17	20

d = d₁ = diametro nominale vite

NOTE

- Le distanze minime sono secondo normativa EN 1995:2014 in accordo a ETA-11/0030.
- Le distanze minime sono indipendenti dall'angolo di inserimento del connettore e dall'angolo della forza rispetto alla fibra.
- La distanza assiale a₂ può essere ridotta fino ad a_{2,LIM} se per ogni connettore viene mantenuta una "superficie di giunzione" a₁a₂ = 25·d₁.
- Per giunzioni trave secondaria-trave principale con viti VGZ d = 7 mm inclinate o incrociate, inserite con angolo di 45° rispetto alla testa della trave secondaria, con un'altezza minima della trave secondaria pari a 18·d, la distanza minima a_{1,CG} può essere assunta pari a 8·d₁ e la distanza minima a_{2,CG} pari a 3·d₁.
- Le distanze tabellate sono riferite a viti inserite in elementi in softwood (legno massiccio o lamellare). Per applicazioni su materiali differenti (es. CLT, LVL), si rimanda ad ETA-11/0030.
- Per l'indicazione delle distanze e delle spaziature si vedano gli schemi riportati a pagina 12.

DISTANZE MINIME PER CONNETTORI INCROCIATI

PUNTE A CONFRONTO: SHARP 1 CUT, 3 THORNS e SELF-DRILLING

 viti inserite **CON** e **SENZA** preforo



$a_{2,CG}$	4·d	4·d	4·d
a_{CROSS}	1,5·d	1,5·d	1,5·d
e	3,5·d	3,5·d	3,5·d

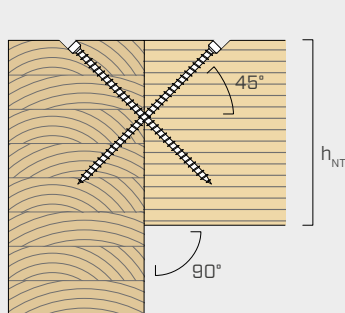

sezione

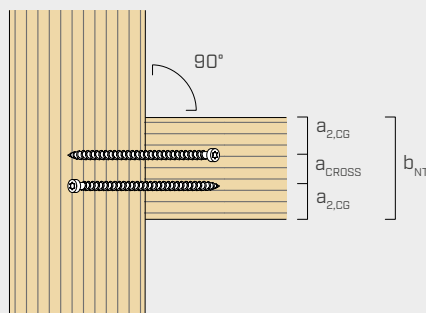

pianta - 1 COPPIA

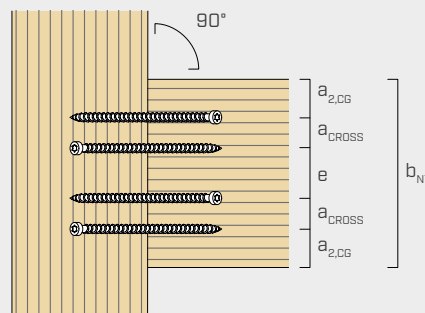

pianta - 2 O PIÙ COPPIE

LARGHEZZA TRAVE SECONDARIA



1 COPPIA - $b_{NT,min}$	$2 \cdot a_{2,CG} + a_{CROSS}$	9,5·d	9,5·d	9,5·d
2 COPPIE - $b_{NT,min}$	$2 \cdot a_{2,CG} + 2 \cdot a_{CROSS} + e$	14,5·d	14,5·d	14,5·d
3 COPPIE - $b_{NT,min}$	$2 \cdot a_{2,CG} + 3 \cdot a_{CROSS} + 2 \cdot e$	19,5·d	19,5·d	19,5·d

NOTE

- Le distanze minime sono secondo normativa EN 1995:2014 in accordo a ETA-11/0030.
- Le distanze minime sono indipendenti dall'angolo di inserimento del connettore e dall'angolo della forza rispetto alla fibra.
- La distanza assiale a_2 può essere ridotta fino ad $a_{2,LIM}$ se per ogni connettore viene mantenuta una "superficie di giunzione" $a_1 \cdot a_2 = 25 \cdot d_1$.
- Per giunzioni trave secondaria-trave principale con viti VGZ $d = 7$ mm inclinate o incrociate, inserite con angolo di 45° rispetto alla testa della trave secondaria, con un'altezza minima della trave secondaria pari a $18 \cdot d$ la distanza minima $a_{2,CG}$ può essere assunta pari a $3 \cdot d_1$.
- Le distanze tabellate sono riferite a viti inserite in elementi in softwood (legno massiccio o lamellare). Per applicazioni su materiali differenti (es. CLT, LVL), si rimanda ad ETA-11/0030.

LEGENDA



punta standard
SHARP 1 CUT
tipo RBN / RBN2



punta
3 THORNS
tipo RB3T



punta
SELF-DRILLING
tipo RBSD

(in graduale transizione verso 3 THORNS e SELF-DRILLING)

(disponibile a partire da **primavera 2024**)

(disponibile a partire da **primavera 2024**)

DISTANZE MINIME PER CONNETTORI INCROCIATI

VITI FILETTO TOTALE

VGZ - VGZ EVO
VGS - VGS EVO

SHARP 1 CUT

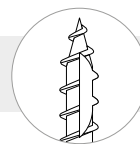

viti inserite CON e SENZA preforo

d ₁	[mm]		5,3	5,6	7	9	11	13
a _{2,CG}	[mm]	4·d	21	22	21(*)	36	44	52
a _{CROSS}	[mm]	1,5·d	8	8	11	14	17	20
e	[mm]	3,5·d	19	20	25	32	39	46

d ₁	[mm]		5,3	5,6	7	9	11	13
1 COPPIA - b _{NT,min}	[mm]	9,5·d	50	53	53(*)	86	105	124
2 COPPIE - b _{NT,min}	[mm]	14,5·d	77	81	88(*)	131	160	189
3 COPPIE - b _{NT,min}	[mm]	19,5·d	103	109	123(*)	176	215	254

VITI FILETTO TOTALE

VGZ - VGZ EVO
VGS - VGS EVO

3 THORNS



viti inserite CON e SENZA preforo

d ₁	[mm]		5,3	5,6	7	9	11	13
a _{2,CG}	[mm]	4·d	21	22	21(*)	36	44	52
a _{CROSS}	[mm]	1,5·d	8	8	11	14	17	20
e	[mm]	3,5·d	19	20	25	32	39	46

d ₁	[mm]		5,3	5,6	7	9	11	13
1 COPPIA - b _{NT,min}	[mm]	9,5·d	50	53	53(*)	86	105	124
2 COPPIE - b _{NT,min}	[mm]	14,5·d	77	81	88(*)	131	160	189
3 COPPIE - b _{NT,min}	[mm]	19,5·d	103	109	123(*)	176	215	254

VITI FILETTO TOTALE

VGZ - VGZ EVO
VGS - VGS EVO

SELF-DRILLING

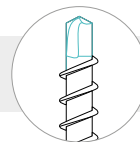

viti inserite CON e SENZA preforo

d ₁	[mm]		9	11	13
a _{2,CG}	[mm]	4·d	36	44	52
a _{CROSS}	[mm]	1,5·d	14	17	20
e	[mm]	3,5·d	32	39	46

d ₁	[mm]		9	11	13
1 COPPIA - b _{NT,min}	[mm]	9,5·d	86	105	124
2 COPPIE - b _{NT,min}	[mm]	14,5·d	131	160	189
3 COPPIE - b _{NT,min}	[mm]	19,5·d	176	215	254

d = d₁ = diametro nominale vite

NOTE

- Le distanze minime sono secondo normativa EN 1995:2014 in accordo a ETA-11/0030.
- Le distanze tabellate sono riferite a viti inserite in elementi in softwood (legno massiccio o lamellare). Per applicazioni su materiali differenti (es. CLT, LVL), si rimanda ad ETA-11/0030.

(*) Per giunzioni trave secondaria-trave principale con viti VGZ d = 7 mm inclinate o incrociate, inserite con angolo di 45° rispetto alla testa della trave secondaria, con un'altezza minima della trave secondaria pari a 18·d la distanza minima a_{2,CG} può essere assunta pari a 3·d₁.

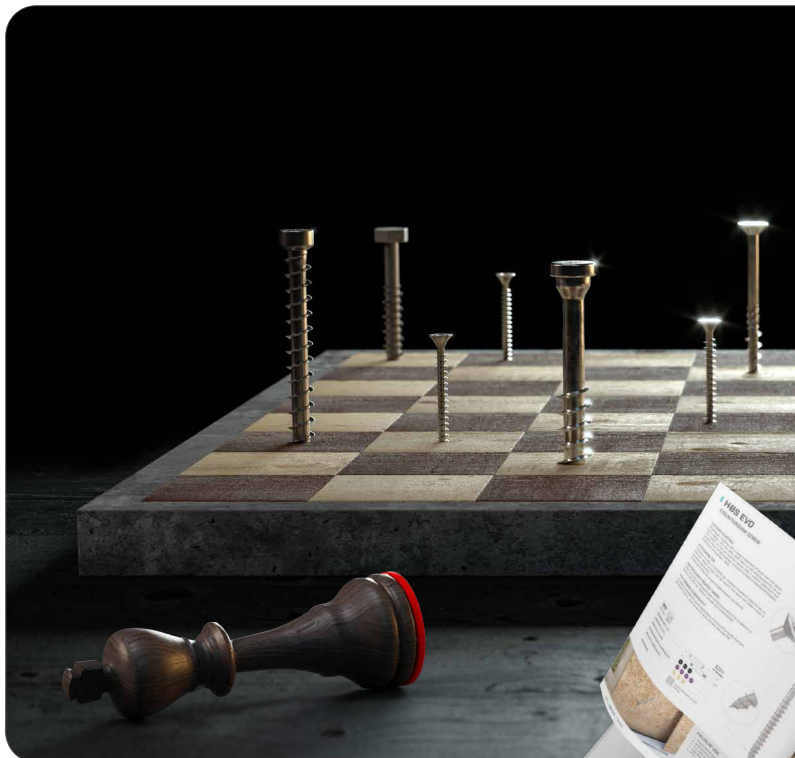

Dove alcuni cedono, altri resistono.

Connettori resistenti, adatti a materiali diversi e a ogni tipo di ambiente, anche il più aggressivo. Giocare una partita così ha infinite mosse e **nuove soluzioni** che siamo pronti a darti.

Fissa le regole della costruzione insieme a noi, sfoglia il catalogo online!

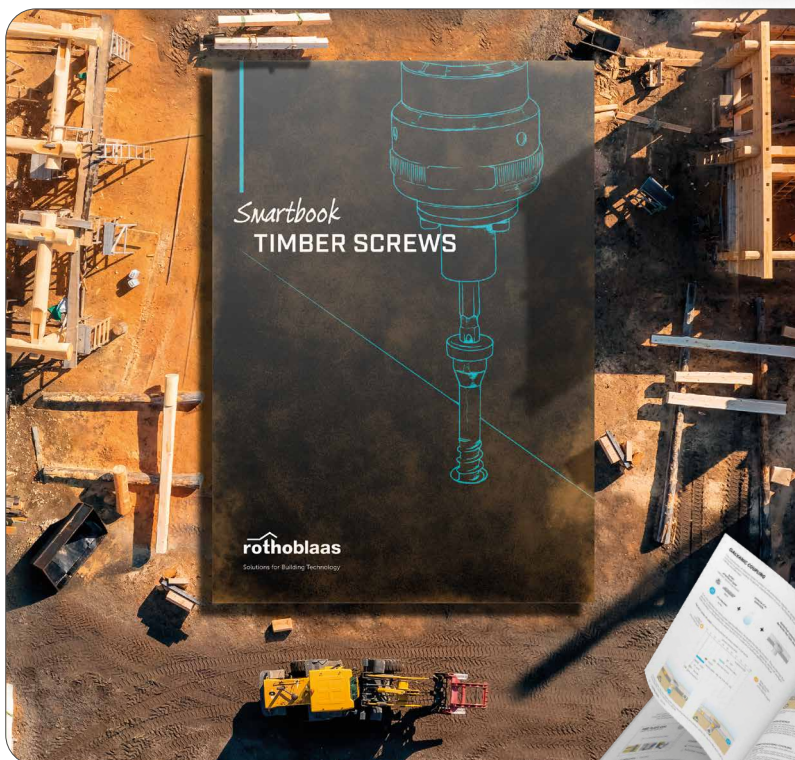

Quanto ne sappiamo di viti?

Teoria, pratica, campagne sperimentali: per mettere insieme tutto sulle viti servono anni di lezioni, laboratori e cantieri. Noi te lo mettiamo a disposizione in 70 pagine extra catalogo.

Perché la nostra esperienza è nelle tue mani.



Rotho Blaas Srl

Via dell'Adige N.2/1 | 39040, Cortaccia (BZ) | Italia
Tel: +39 0471 81 84 00 | Fax: +39 0471 81 84 84
info@rothoblaas.com | www.rothoblaas.com

